

# PLETHYSMS OF SYMMETRIC FUNCTIONS AND REPRESENTATIONS OF $\mathrm{SL}_2(\mathbf{C})$

ROWENA PAGET AND MARK WILDON

ABSTRACT. Let  $\nabla^\lambda$  denote the Schur functor labelled by the partition  $\lambda$  and let  $E$  be the natural representation of  $\mathrm{SL}_2(\mathbf{C})$ . We make a systematic study of when there is an isomorphism  $\nabla^\lambda \mathrm{Sym}^\ell E \cong \nabla^\mu \mathrm{Sym}^m E$  of representations of  $\mathrm{SL}_2(\mathbf{C})$ . Generalizing earlier results of King and Manivel, we classify all such isomorphisms when  $\lambda$  and  $\mu$  are conjugate partitions and when one of  $\lambda$  or  $\mu$  is a rectangle. We give a complete classification when  $\lambda$  and  $\mu$  each have at most two rows or columns or is a hook partition and a partial classification when  $\ell = m$ . As a corollary of a more general result on Schur functors labelled by skew partitions we also determine all cases when  $\nabla^\lambda \mathrm{Sym}^\ell E$  is irreducible. The methods used are from representation theory and combinatorics; in particular, we make explicit the close connection with MacMahon's enumeration of plane partitions, and prove a new  $q$ -binomial identity in this setting.

## 1. INTRODUCTION

Let  $\mathrm{SL}_2(\mathbf{C})$  be the special linear group of  $2 \times 2$  complex matrices of determinant 1 and let  $E$  be its natural 2-dimensional representation. The irreducible complex representations of  $\mathrm{SL}_2(\mathbf{C})$  are, up to isomorphism, precisely the symmetric powers  $\mathrm{Sym}^n E$  for  $n \in \mathbf{N}_0$ . A classical result, discovered by Cayley and Sylvester in the setting of invariant theory, states that if  $a, b \in \mathbf{N}$  then the representations  $\mathrm{Sym}^a \mathrm{Sym}^b E$  and  $\mathrm{Sym}^b \mathrm{Sym}^a E$  of  $\mathrm{SL}_2(\mathbf{C})$  are isomorphic. More recently, King and Manivel independently proved that  $\nabla^{(a^b)} \mathrm{Sym}^{b+c-1} E$  is invariant, up to  $\mathrm{SL}_2(\mathbf{C})$ -isomorphism, under permutation of  $a, b$  and  $c$ . Here  $\nabla^{(a^b)}$  is an instance of the Schur functor  $\nabla^\lambda$ , defined in §2.4. Motivated by these results, the purpose of this article is to make a systematic study of when there is a *plethystic isomorphism*

$$(1.1) \quad \nabla^\lambda \mathrm{Sym}^\ell E \cong \nabla^\mu \mathrm{Sym}^m E$$

of  $\mathrm{SL}_2(\mathbf{C})$ -representations. By taking the characters of each side, (1.1) is equivalent to

$$(1.2) \quad q^{-\ell|\lambda|/2} s_\lambda(1, q, \dots, q^\ell) = q^{-m|\mu|/2} s_\mu(1, q, \dots, q^m).$$

---

*Date:* March 22, 2020.

*2010 Mathematics Subject Classification.* 05E05, Secondary: 05E10, 20C30, 22E46, 22E47.

where  $s_\lambda$  is the Schur function for the partition  $\lambda$ . By Remark 2.9, we also have  $s_\lambda(1, q, \dots, q^\ell) = (s_\lambda \circ s_\ell)(1, q)$  where  $\circ$  is the plethysm product. Thus (1.1) can be investigated using a circle of powerful combinatorial ideas; these include Stanley's Hook Content Formula [29, Theorem 7.21.2].

Our results reveal numerous surprising isomorphisms, not predicted by any existing results in the literature, and a number of new obstacles to plethystic isomorphism. In particular, we prove a converse to the King and Manivel result. We also note Lemma 4.4, which implies that, in the typical case for (1.2), the Young diagrams of  $\lambda$  and  $\mu$  have the same number of removable boxes. Borrowing from the title of [17], these are all cases where one may 'hear the shape of a partition'.

**Main results.** Let  $\ell(\lambda)$  denote the number of parts of a partition  $\lambda$  and let  $a(\lambda)$  denote its first part, setting  $a(\emptyset) = 0$ .

**Definition 1.1.** Given non-empty partitions  $\lambda$  and  $\mu$  and  $\ell, m \in \mathbf{N}$  such that  $\ell \geq \ell(\lambda) - 1$  and  $m \geq \ell(\mu) - 1$ , we set  $\lambda \underset{\ell}{\sim}_m \mu$  if and only if  $\nabla^\lambda \text{Sym}^\ell E \cong \nabla^\mu \text{Sym}^m E$  as representations of  $\text{SL}_2(\mathbf{C})$ .

We refer to the relation  $\underset{\ell}{\sim}_m$  as *plethystic equivalence*. By Lemma 4.1, we have  $\lambda \underset{\ell(\lambda)-1}{\sim}_{\ell(\lambda)-1} \bar{\lambda}$ , where, by definition,  $\bar{\lambda}$  is  $\lambda$  with its columns of length  $\ell(\lambda)$  removed. Such plethystic equivalences arise from the triviality of the representation  $\bigwedge^{\ell+1} \text{Sym}^\ell$  of  $\text{SL}(E)$ ; as we show in Example 1.12 below, they can be dispensed with by using Lemma 4.2 and Proposition 4.3 to reduce to the following 'prime' case.

**Definition 1.2.** A plethystic equivalence  $\lambda \underset{\ell}{\sim}_m \mu$  is *prime* if  $\ell \geq \ell(\lambda)$  and  $m \geq \ell(\mu)$ .

To avoid technicalities, we state our first main theorem in a slightly weaker form than in the main text. Given a partition  $\lambda$  with Durfee square of size  $d$ , let  $\mathcal{EP}(\lambda)$  be the partition, shown in Figure 1 in §5, obtained from the first  $d$  rows of  $\lambda$  by deleting the maximal rectangle containing the Durfee square of  $\lambda$ . Let  $\mathcal{SP}(\lambda)$  be defined analogously, replacing rows with columns. Thus  $\mathcal{SP}(\lambda) = \mathcal{EP}(\lambda')$  where  $\lambda'$  is the conjugate partition to  $\lambda$ . The 'if' direction of the theorem below was proved by King in [18, §4] and is also Cagliero and Penazzi's main result in [3].

**Theorem 1.3.** *Let  $\lambda$  and  $\mu$  be partitions. There exist infinitely many pairs  $(\ell, m)$  such that  $\lambda \underset{\ell}{\sim}_m \mu$  if and only if  $\mathcal{EP}(\lambda) = \mathcal{SP}(\lambda)'$  and  $\mu = \lambda'$ . In this case, the pairs are all  $(\ell, m)$  such that  $\ell = \ell(\lambda) - 1 + k$  and  $m = \ell(\mu) - 1 + k$  for some  $k \in \mathbf{N}_0$ .*

Our second main theorem sharpens this result to show that 'infinitely many' may be replaced with 'three', and, in the case of prime equivalences, with 'two'.

**Theorem 1.4.** *Let  $\lambda$  and  $\mu$  be partitions.*

(i) *There are two distinct pairs  $(\ell, m)$ ,  $(\ell^\dagger, m^\dagger)$  such that  $\lambda_{\ell \sim m} \mu$  and  $\lambda_{\ell^\dagger \sim m^\dagger} \mu$  are prime plethystic equivalences if and only if either  $\lambda = \mu$  or  $\mathcal{EP}(\lambda) = \mathcal{SP}(\lambda)'$  and  $\lambda = \mu'$ .*

(ii) *There are three distinct pairs  $(\ell, m)$ ,  $(\ell^\dagger, m^\dagger)$ ,  $(\ell^\ddagger, m^\ddagger)$  such that  $\lambda_{\ell \sim m} \mu$ ,  $\lambda_{\ell^\dagger \sim m^\dagger} \mu$  and  $\lambda_{\ell^\ddagger \sim m^\ddagger} \mu$  if and only if either  $\lambda = \mu$  or  $\mathcal{EP}(\lambda) = \mathcal{SP}(\lambda)'$  and  $\lambda = \mu'$ .*

(iii) *There exist distinct  $n, n^\dagger \in \mathbf{N}$  such that  $\lambda_n \sim_n \mu$  and  $\lambda_{n^\dagger} \sim_{n^\dagger} \mu$  if and only if  $\lambda = \mu$ .*

It is clear that no still sharper result can hold in (i) or (iii); Example 1.12 below shows that the same is true for (ii).

If  $\ell(\lambda) \leq r$ , let  $\lambda^{\circ r}$  denote the complementary partition to  $\lambda$  in the  $r \times a(\lambda)$  box, defined formally by  $\lambda_{r+1-i}^{\circ r} = a(\lambda) - \lambda_i$  for  $1 \leq i \leq r$ . The ‘if’ direction of the following theorem was proved in [18, §4].

**Theorem 1.5.** *Let  $r \in \mathbf{N}$  and let  $\lambda$  be a partition with  $\ell(\lambda) \leq r$ . Then  $\lambda_{\ell \sim \ell} \lambda^{\circ r}$  if and only if  $r = \ell + 1$  or  $\lambda = \lambda^{\circ r}$ .*

Our fourth main result includes the converse of the King and Manivel six-fold symmetries mentioned at the outset. Again, to avoid technicalities, we state it in a slightly weaker form below.

**Theorem 1.6.** *Let  $\lambda$  be a partition and let  $a, b, c \in \mathbf{N}$ . If  $\ell \geq \ell(\lambda)$  then  $\lambda_{\ell \sim b+c-1} (a^b)$  if and only if  $\lambda$  is rectangular, with  $\lambda = (a^{b'})$ , and  $(a', b', \ell - b' + 1)$  is a permutation of  $(a, b, c)$ .*

Extending a remark of King and part of Manivel’s proof, we show that the ‘if’ direction of Theorem 1.6 is the representation-theoretic realization of the six-fold symmetry group of plane partitions; these symmetries generalize conjugacy for ordinary partitions. MacMahon [21] found a beautiful closed form for the generating function of plane partitions that makes these symmetries algebraically obvious. We use this to prove a new  $q$ -binomial identity that implies the symmetry by swapping  $b$  and  $c$ .

Taking  $b = 1$  in the full version of Theorem 1.6 we obtain the following classification, notable because of the connection with Hermite reciprocity and Foulkes’ Conjecture discussed later in the introduction.

**Corollary 1.7.** *Let  $\lambda$  be a partition and let  $a, c \in \mathbf{N}$ . There is an isomorphism  $\nabla^\lambda \text{Sym}^\ell E \cong \text{Sym}^a \text{Sym}^c E$  of  $\text{SL}_2(\mathbf{C})$ -representations if and only if  $\lambda$  is obtained by adding columns of length  $\ell + 1$  to one of the partitions  $(a)$ ,  $(1^a)$ ,  $(c)$ ,  $(1^c)$ ,  $(a^c)$ ,  $(c^a)$ , and  $\ell$  is respectively  $c$ ,  $a + c - 1$ ,  $a$ ,  $a + c - 1$ ,  $c$ ,  $a$ .*

The entirely new results begin in §9 where we consider skew Schur functions and prove a necessary and sufficient condition for  $s_{\lambda/\lambda^*}(1, q, \dots, q^\ell)$  to be equal, up to a power of  $q$ , to  $1 + q + \dots + q^n$  for some  $n \in \mathbf{N}_0$ . This

is equivalent to the irreducibility of  $\nabla^{\lambda/\lambda^*}E$ . (We outline a construction of skew Schur functors in Remark 9.2 below.) Specializing this result to partitions, we characterize all irreducible plethysms.

**Corollary 1.8.** *Let  $\lambda$  be a partition and let  $\ell \in \mathbf{N}$ . There exists  $m \in \mathbf{N}_0$  such that  $\nabla^\lambda \text{Sym}^\ell E \cong \text{Sym}^m E$  if and only if one of the following holds:*

- (i)  $\ell = 1$ ,  $\lambda = (n - k, k)$  for some  $k \leq n/2$  and  $m = n - 2k$ ;
- (ii)  $\ell \geq 2$  and either  $\lambda = (p^{\ell+1})$  and  $m = 0$  or  $\lambda = (p, (p - 1)^\ell)$  and  $m = \ell$  or  $\lambda = (p^\ell, p - 1)$  for some  $p \in \mathbf{N}$  and  $m = \ell$ .

Since  $\nabla^\lambda \text{Sym}^\ell E$  is irreducible if and only if  $\lambda_{\ell \sim_1} (n)$  for some  $n \in \mathbf{N}_0$ , Corollary 1.8 can also be obtained from the full version of Theorem 1.6, or, more directly, from Corollary 1.7.

In §10 we classify all equivalences  $\lambda_{\ell \sim_m} \mu$  when  $\lambda$  and  $\mu$  are two-row, two-column or hook partitions. To give a good flavour of this, we state the result for equivalences between two-row and hook partitions.

**Theorem 1.9.** *Let  $\lambda$  be a non-hook partition with exactly two parts and let  $\mu$  be a hook partition with non-zero arm length and leg length. If  $\ell \geq \ell(\lambda)$  and  $m \geq \ell(\mu)$  then  $\lambda_{\ell \sim_m} \mu$  if and only if the relation is one of*

- (i)  $(a, b)_{a-b+1 \sim_a} (a - b + 1, 1^b)$   
 $(a, b)_{a-b+1 \sim_{2(a-b)}} (b + 1, 1^{a-b})$ ,
- (ii)  $(3\ell - 3, 2\ell - 1)_{\ell \sim_{3\ell-4}} (\ell + 1, 1^{\ell-2})$   
 $(3\ell - 3, 2\ell - 1)_{\ell \sim_{3\ell-2}} (\ell - 1, 1^\ell)$ .

In §11 we consider the case of prime equivalences in which  $\ell = m$ . Building on Theorem 1.5, we obtain the following partial classification.

**Theorem 1.10.** *Let  $\lambda$  and  $\mu$  be partitions and let  $\ell \geq \ell(\lambda), \ell(\mu)$ .*

- (a) *If  $\ell \leq 4$  then  $\lambda_{\ell \sim_\ell} \mu$  if and only if  $\lambda = \mu$  or  $\lambda^{\circ(\ell+1)} = \mu$ .*
- (b) *For all  $\ell \geq 5$  there exist infinitely many distinct pairs  $(\lambda, \mu)$  such that  $\lambda \neq \mu$ ,  $\lambda \neq \mu^{\circ(\ell+1)}$ , and  $\lambda_{\ell \sim_\ell} \mu$ .*

We end in §12 where we show that there exist infinitely many partitions whose only plethystic equivalences are the inevitable column removals from Lemma 4.1 and the complement equivalences from Theorem 1.5.

**Theorem 1.11.** *Let  $\delta(k) = (k, k - 1, \dots, 1)$  and let  $\ell, m \in \mathbf{N}$ . Let  $\mu$  be a partition. Suppose that  $\ell \geq k$  and  $m \geq \ell(\mu)$  and that  $\mu \neq \delta(k)$ . Then  $\delta(k)_{\ell \sim_m} \mu$  if and only if  $\ell = m$ ,  $\ell > k$  and  $\mu = \delta(k)^{\circ(\ell+1)}$ .*

The complex behaviour of plethystic equivalences revealed by our main theorems strongly suggests that a complete classification is infeasible. By size of the partitions, the smallest example of a plethystic equivalence not explained by any of our results is  $(3, 3, 2)_{9 \sim_{10}} (2, 2, 2, 2, 1, 1)$ .

The following example is chosen to illustrate many of our main results.

**Example 1.12.** Let  $b, c, d \in \mathbf{N}$ . Since  $((b+c)^c, c^d)$  is the complement of  $((b+c)^b, b^d)$  in the  $(b+c+d) \times (b+c)$  box, Theorem 1.5 implies that

$$((b+c)^b, b^d)_{b+c+d-1} \sim_{b+c+d-1} ((b+c)^c, c^d).$$

The column removals relevant to Lemma 4.1 are  $\overline{((b+c)^b, b^d)} = (c^b)$  and  $\overline{((b+c)^c, c^d)} = (b^c)$ . By Lemma 4.1 there are non-prime plethystic equivalences  $((b+c)^b, b^d)_{b+d-1} \sim_{b+d-1} (c^b)$  and  $((b+c)^c, c^d)_{c+d-1} \sim_{c+d-1} (b^c)$ . By either Theorem 1.3 or Theorem 1.6, we have  $(c^b)_{b+d-1} \sim_{c+d-1} (b^c)$ . Thus

$$((b+c)^b, b^d)_{b+d-1} \sim_{b+d-1} (c^b)_{b+d-1} \sim_{c+d-1} (b^c)_{c+d-1} \sim_{c+d-1} ((b+c)^c, c^d).$$

By Lemma 4.2 this chain can be read as the factorization of a non-prime plethystic equivalence

$$((b+c)^b, b^d)_{b+d-1} \sim_{c+d-1} ((b+c)^c, c^d).$$

By Theorem 1.4(ii), there are precisely two plethystic equivalences between  $((b+c)^b, b^d)$  and  $((b+c)^c, c^d)$ , namely the two found above. As expected from this theorem, only one of these equivalences is prime.

**1.1. Outline.** In the remainder of this introduction we illustrate the critical Theorem 3.4, which collects a number of equivalent conditions for the plethystic equivalence in Definition 1.1 by giving two short proofs that  $\text{Sym}^a \text{Sym}^b E \cong \text{Sym}^b \text{Sym}^a E$  for all  $a, b \in \mathbf{N}_0$ . In the spirit of this work, one proof also gives a converse. We then give a brief literature survey, organized around the different generalizations of this isomorphism.

In §2 we construct the irreducible representations of  $\text{SL}_2(\mathbf{C})$  as the symmetric powers  $\text{Sym}^\ell E$ , and give other basic results from representation theory. We then give an explicit model for the representations  $\nabla^\lambda \text{Sym}^\ell E$ . While  $\nabla^\lambda E$  is non-zero only if  $\ell(\lambda) \leq 2$ , the representation  $\nabla^\lambda \text{Sym}^\ell E$  is non-zero whenever  $\ell \geq \ell(\lambda) - 1$ . This explains the ubiquity of this condition in this work, and why we require the generality of Schur functors, despite working only with representations of  $\text{GL}_2(\mathbf{C})$  and its subgroups. To make the paper largely self-contained, we end by defining Schur functions.

The reader may prefer to treat §2 as a reference and begin reading in §3, where we state and prove Theorem 3.4. In §4 we collect some useful basic properties of the relations  $\ell \sim_m$ . In §§5–12 we prove the main results, as already outlined. Theorem 1.5 requires the statement of Theorem 1.4, which in turn uses the statement of Theorem 1.3; several later theorems need the statement of Theorem 1.5. Apart from this, the sections may be read independently.

**1.2. Hermite reciprocity.** The isomorphism  $\text{Sym}^n \text{Sym}^\ell E \cong \text{Sym}^\ell \text{Sym}^n E$  of  $\text{GL}_2(\mathbf{C})$ -representations for  $n, \ell \in \mathbf{N}$  was first discovered, in the context of invariant theory, by Hermite [14, end §1]. It was observed by Cayley in [4, §20], where he acknowledges Hermite's prior discovery; some special

cases may be seen in Sylvester [31], published in the same journal issue as [14]. Thus it is also known (for instance in the title of [22]) as the Cayley–Sylvester formula. An invariant theory proof in modern language may be found in [28, 3.3.4]. Another elegant proof, using the symmetric group, is in [13, Corollary 2.12]. We offer two proofs that illustrate different conditions in Theorem 3.4. Each shows that  $(n)_{\ell \sim n}(\ell)$ , or equivalently, Hermite reciprocity for representations of  $\mathrm{SL}_2(\mathbf{C})$ . Then, since the degrees on each side are equal, it follows from Proposition 3.6 that there is a  $\mathrm{GL}_2(\mathbf{C})$ -isomorphism. The first proof is well known, and is sketched in [11, Exercise 6.19]; later in §8.1 we give its generalization to plane partitions. Yet another proof (including the converse) can be given using Theorem 3.4(i).

*Proof by tableaux.* By Theorem 3.4(g), we have  $(n)_{\ell \sim n}(\ell)$  if and only if  $|\mathcal{S}_e^\ell(n)| = |\mathcal{S}_e^n(\ell)|$  for all  $e \in \mathbf{N}_0$ , where, by definition,  $\mathcal{S}_e^\ell(n)$  is the set of semistandard tableaux of shape  $(n)$  with entries from  $\{0, 1, \dots, \ell\}$  whose sum of entries is  $e$ . Let  $t$  be such a tableau, having exactly  $c_i$  entries of  $i$  for each  $i \in \{0, 1, \dots, \ell\}$ . Then, reading its unique row from right to left, and ignoring any zeros,  $t$  encodes the partition  $(\ell^{c_\ell}, \dots, 1^{c_1})$  of  $e$ . Hence  $|\mathcal{S}_e^\ell(n)|$  is the number of partitions of  $e$  whose diagram is contained in the  $n \times \ell$  box. By conjugating partitions, this number is invariant under swapping  $n$  and  $\ell$ .  $\square$

*Proof by Stanley’s Hook Content Formula.* The content of the partition  $(n)$  is  $\{0, 1, \dots, n-1\}$ , and its hook lengths are  $\{1, 2, \dots, n\}$ . (These terms are defined in Definition 2.11.) By Theorem 3.4(h),  $(n)_{\ell \sim m}(n')$  if and only if  $\{\ell+1, \ell+2, \dots, n+\ell\} / \{1, 2, \dots, n\} = \{m+1, m+2, \dots, m+n'\} / \{1, 2, \dots, n'\}$ , where  $/$  denotes a difference multiset, as defined in §3.1. Equivalently, the multiset unions  $\{\ell+1, \ell+2, \dots, n+\ell\} \cup \{1, 2, \dots, n'\}$  and  $\{m+1, m+2, \dots, m+n'\} \cup \{1, 2, \dots, n\}$  are equal. If  $n = n'$  then, cancelling  $\{1, 2, \dots, n\}$  from each side, we see that  $\ell = m$ , giving a trivial solution. Otherwise we may suppose by symmetry that  $n < n'$ . Now  $n+1$  is in the first union and so  $m = n$ ; comparing greatest elements we see that  $n' = \ell$ . We therefore have  $n' = \ell$  and  $m = n$ , corresponding to Hermite reciprocity.  $\square$

We remark that the first proof shows that that partitions contained in the  $n \times \ell$  box are enumerated, according to their size, by a character of  $\mathrm{SL}_2(\mathbf{C})$ . In particular by Theorem 3.4, the sequence is unimodal that is, first weakly increasing and then weakly decreasing.

**1.3. Literature on  $\mathrm{SL}_2(\mathbf{C})$ -plethysms.** By Hermite reciprocity, the multiplicity of any Schur function  $s_{(\ell n-d, d)}$  labelled by a two-part partition is the same in  $s_{(n)} \circ s_{(\ell)}$  and  $s_{(\ell)} \circ s_{(n)}$ . More generally, Foulkes conjectured in [8] that if  $n \geq \ell$  then  $s_{(n)} \circ s_{(\ell)} - s_{(\ell)} \circ s_{(n)}$  is a non-negative integral

linear combination of Schur functions; Foulkes' Conjecture has been proved only when  $n \leq 5$  (see [5]) and when  $n$  is very large compared to  $\ell$  (see [2]). A number of 'stability' results on plethysm are relevant to this setting. For example, a special case of the theorem on page 354 of [2] implies that the multiplicity of  $\text{Sym}^r E$  in  $\text{Sym}^n \text{Sym}^\ell E$  is at most the multiplicity of  $\text{Sym}^{r+n} E$  in  $\text{Sym}^n \text{Sym}^{\ell+1} E$ . The first proof of Hermite reciprocity above translates this into a non-trivial combinatorial result comparing partitions of  $r$  in the  $n \times \ell$  box and partitions of  $r+n$  in the  $n \times (\ell+1)$  box.

In [18], King proves the 'if' direction of Theorem 1.6, and sketches a proof of a weaker version of the converse. He mentions as one motivation the Wronskian isomorphism  $\bigwedge^b \text{Sym}^{b+c-1} E \cong \text{Sym}^b \text{Sym}^c E$  of representations of the compact subgroup  $\text{SU}_2(\mathbf{C})$  of  $\text{SL}_2(\mathbf{C})$ . This is interpreted by Wybourne in [32] as an equality between the number of completely antisymmetric states of  $b+c-1$  identical bosons each of angular momentum  $c/2$  and the number of symmetric states of  $b$  identical bosons each of angular momentum  $c/2$ . (There is a typographic error between (13) and (14) in [32];  $m+1+n$  should be  $m+1-n$ , as in (13).) This realizes the well-known equality between the number of  $c$ -multisubsets of  $\{1, \dots, b\}$  and the number of  $c$ -subsets of  $\{1, \dots, b+c-1\}$ . By Lemma 5.1 in [23], the special case of the Wronskian isomorphism  $\bigwedge^2 \text{Sym}^{c+1} E \cong \text{Sym}^2 \text{Sym}^c E$  holds when  $E$  is the natural representation of any finite special linear group  $\text{SL}_2(\mathbb{F}_q)$  when  $q$  is odd. It would be interesting to have further examples of such 'modular plethysms'.

The second main result of [1] classifies all partitions  $\lambda$  and  $\nu$  such that the plethysm  $s_\lambda \circ s_\nu$  is equal to a single Schur function. Apart from the obvious  $s_\lambda \circ s_{(1)} = s_\lambda$ , the only examples are  $s_{(1,1)} \circ s_{(1,1)} = s_{(2,1,1)}$  and  $s_{(1,1)} \circ s_{(2)} = s_{(3,1)}$ . By Remark 2.9 and (2.8), the formal character of  $\nabla^\lambda \text{Sym}^\ell E$ , evaluated at 1 and  $q$  is  $(s_\lambda \circ s_{(\ell)})(1, q)$ . Our Corollary 1.8 therefore shows that there are more irreducible plethysms when we work with symmetric functions truncated to two variables. The equality  $(s_{(1^5)} \circ s_{(2)})(x_1, x_2, x_3) = s_{(2,2)}(x_1, x_2, x_3)$ , corresponding to the isomorphism  $\bigwedge^5 \text{Sym}^2 U \cong \nabla^{(2,2)} U$  where  $U$  is a 3-dimensional complex vector space, gives a similar 'non-generic' example for three variables.

Corollary 1.8 is itself a special case of Theorem 9.5 on skew Schur functors. While we do not require it in this work, we note that a combinatorial formula for the corresponding plethysm  $s_{\lambda/\lambda^*}(1, q, \dots, q^\ell) = (s_{\lambda/\lambda^*} \circ s_{(\ell)})(1, q)$  is given by Morales, Pak and Panova in [24, Theorem 1.4] in terms of certain 'excited' Young diagrams of shape  $\lambda/\lambda^*$  first defined by Ikeda and Naruse in [15]. This result is a generalization of Stanley's Hook Content Formula (see [29, Theorem 7.21.2]), one of the main tools in this work. As a corollary the authors obtain a formula due to Naruse [25] for the number of standard tableaux of shape  $\lambda/\lambda^*$ .

For further general background on plethysms we refer the reader to [19] and to the survey in [26].

## 2. BACKGROUND

**2.1. Representations of  $\mathrm{SL}_2(\mathbf{C})$ .** Let  $G$  be a subgroup of  $\mathrm{GL}_2(\mathbf{C})$  containing  $\mathrm{SL}_2(\mathbf{C})$ . A representation  $\rho : G \rightarrow \mathrm{GL}(V)$  is said to be *polynomial* if, with respect to a chosen basis of  $V$ , each matrix entry in  $\rho(g)$  is a polynomial in the matrix entries of  $g \in G$ . If these polynomials all have the same degree  $r$ , we say that  $V$  has *degree  $r$* . We define the *character* of a polynomial representation  $V$  of  $G$  to be the unique two variable polynomial  $\Phi_V$  such that

$$\mathrm{Tr}_V \begin{pmatrix} \alpha & 0 \\ 0 & \beta \end{pmatrix} = \Phi_V(\alpha, \beta)$$

for all non-zero  $\alpha, \beta \in \mathbf{C}$ . We define the  *$Q$ -character* of  $V$  to be the Laurent polynomial  $\Psi_V$  such that  $\Psi_V(Q) = \Phi_V(Q^{-1}, Q)$ .

Remarkably every smooth representation of  $\mathrm{SL}_2(\mathbf{C})$  is polynomial. Thus the following summary theorem is a restatement of a basic result in Lie Theory.

**Theorem 2.1.** *Let  $V$  be a polynomial representation of  $\mathrm{SL}_2(\mathbf{C})$ . Then  $V$  is isomorphic to a direct sum of irreducible representations. Moreover, if  $V$  is irreducible then there exists a unique  $\ell \in \mathbf{N}_0$  such that  $V \cong \mathrm{Sym}^\ell E$ .*

*Proof.* See [12, Chapter 12]. □

Let  $E$  be a 2-dimensional complex vector space with basis  $e_1, e_2$ . The diagonal matrix with entries  $1/\alpha$  and  $\alpha$  acts on the canonical basis element  $e_1^{l-k}e_2^k$  of  $\mathrm{Sym}^\ell E$  by multiplication by  $\alpha^{2k-\ell}$ . Therefore

$$(2.1) \quad \Phi_{\mathrm{Sym}^\ell E}(x, y) = x^\ell + \cdots + xy^{\ell-1} + y^\ell,$$

and so

$$(2.2) \quad \Psi_{\mathrm{Sym}^\ell E}(Q) = Q^{-\ell} + \cdots + Q^{\ell-2} + Q^\ell.$$

**Lemma 2.2.** *Let  $V$  be a polynomial representation of  $\mathrm{SL}_2(\mathbf{C})$ . Then  $V$  is determined up to isomorphism by its  $Q$ -character  $\Psi_V$ . Moreover,  $\Psi_V(Q) = \Psi_V(Q^{-1})$ .*

*Proof.* Since the Laurent polynomials in (2.2) are linearly independent, the result is immediate from Theorem 2.1. □

**2.2. Partitions.** Let  $\mathrm{Par}(r)$  denote the set of partitions of  $r \in \mathbf{N}$ . We write  $|\lambda| = r$  if  $\lambda \in \mathrm{Par}(r)$ . We have already introduced the notation  $\ell(\lambda)$  for the number of parts of  $\lambda$ . If  $i > \ell(\lambda)$  then we set  $\lambda_i = 0$ . The *Young diagram* of  $\lambda$  is the set  $\{(i, j) : 1 \leq i \leq \ell(\lambda), 1 \leq j \leq \lambda_i\}$ ; we refer to its elements as *boxes*, and draw  $[\lambda]$  using the ‘English’ convention with its longest row at the top of the page, as in Example 2.6 below.



**2.3. Tableaux.** A  $\lambda$ -tableau is a function  $t : [\lambda] \rightarrow \mathbf{N}_0$ . If  $t(i, j) = b$ , then we say that  $t$  has *entry*  $b$  in box  $(i, j)$ , and write  $t_{(i,j)} = b$ . If the entries of each row of  $t$  are weakly increasing when read from left to right we say that  $t$  is *row-semistandard*. If the entries of each column of  $t$  are strictly increasing when read from top to bottom, we say that  $t$  is *column standard*. If both conditions hold, we say that  $t$  is *semistandard*. Let  $\text{RSSYT}_{\leq \ell}(\lambda)$  and  $\text{SSYT}_{\leq \ell}(\lambda)$  be the sets of row semistandard and semistandard  $\lambda$ -tableaux respectively, with entries in  $\{0, 1, \dots, \ell\}$ . Note that 0 is permitted as an entry. Given a permutation  $\sigma$  of the boxes  $[\lambda]$ , and a  $\lambda$ -tableau  $t$ , we define  $\sigma \cdot t$  by  $(\sigma \cdot t)(i, j) = t(\sigma^{-1}(i, j))$ . Thus if  $t$  has entry  $b$  in box  $(i, j)$  then  $\sigma \cdot t$  has entry  $b$  in box  $\sigma(i, j)$ . Let  $C(\lambda)$  be the group of all permutations that permute within themselves boxes in the same column of  $[\lambda]$ .

We define the *weight* of tableau  $t$ , denoted  $|t|$ , to be the sum of its entries.

**2.4. A construction of  $\nabla^\lambda \text{Sym}^\ell E$ .** Fix  $\ell \in \mathbf{N}$  and let  $V = \langle v_0, \dots, v_\ell \rangle$  be an  $(\ell + 1)$ -dimensional complex vector space. Given a  $\lambda$ -tableau  $t$  with entries from  $\{0, 1, \dots, \ell\}$ , define

$$(2.3) \quad f(t) = \bigotimes_{i=1}^{\ell(\lambda)} \prod_{j=1}^{\lambda_i} v_{t(i,j)} \in \bigotimes_{i=1}^{\ell(\lambda)} \text{Sym}^{\lambda_i} V.$$

Define

$$(2.4) \quad F(t) = \sum_{\tau \in C(t)} \text{sgn}(\tau) f(\tau \cdot t).$$

We say that  $F(t)$  is the *GL-polytabloid corresponding to  $t$* . Observe that if  $\sigma \in C(t)$  then

$$(2.5) \quad F(\sigma \cdot t) = \text{sgn}(\sigma) F(t).$$

Hence  $F(t) = 0$  if  $t$  has a repeated entry in a column.

It is clear that  $\{f(t) : t \in \text{RSSYT}_{\leq \ell}(\lambda)\}$  is a basis of  $\bigotimes_{i=1}^{\ell(\lambda)} \text{Sym}^{\lambda_i} V$ . Thus given any  $g \in \text{GL}(V)$ , there exist unique coefficients  $\alpha_s \in \mathbf{C}$  for  $s \in \text{RSSYT}_{\leq \ell}(\lambda)$  such that

$$gf(t) = \sum_{s \in \text{RSSYT}_{\leq \ell}(\lambda)} \alpha_s f(s).$$

It is routine to check that if  $\sigma$  is a permutation of  $[\lambda]$  then  $gf(\sigma \cdot t) = \sum_{s \in \text{RSSYT}_{\leq \ell}(\lambda)} \alpha_s f(\sigma \cdot s)$ . It now follows from the definition in (2.4) that the linear span of the  $F(t)$  for  $t$  a  $\lambda$ -tableau with entries from  $\{0, 1, \dots, \ell\}$  is a  $\text{GL}(V)$ -subrepresentation of  $\bigotimes_{i=1}^{\ell(\lambda)} \text{Sym}^{\lambda_i} V$ ; this is  $\nabla^\lambda V$ . In particular, it is clear that  $\nabla^{(n)} V \cong \text{Sym}^n V$  for each  $n \in \mathbf{N}_0$ .

**Example 2.3.** By (2.5) the representation  $\nabla^{(1^n)} V$  has as a basis all GL-polytabloids  $F(t)$  where  $t$  is a standard  $(1^n)$ -tableau with entries from  $\{0, 1, \dots, \ell\}$ . Moreover, the linear map  $\nabla^{(1^n)} V \rightarrow \bigwedge^n V$  defined by  $F(t) \mapsto v_{t_{(1,1)}} \wedge$

$\cdots \wedge v_{t_{(n,1)}}$  is an isomorphism of representations of  $\mathrm{GL}(V)$ . In particular, if  $n = \ell + 1$  then  $\nabla^{(1^n)}$  is the determinant representation of  $\mathrm{GL}(V)$ .

More generally we have the following theorem.

**Theorem 2.4.** *The GL-polytabloids  $F(s)$  for  $s \in \mathrm{SSYT}_{\leq \ell}(\lambda)$  are a  $\mathbf{C}$ -basis of  $\nabla^\lambda V$ .*

*Proof.* See either [7, Proposition 2.11] or [10, Chapter 8].  $\square$

**Definition 2.5.** Let  $\lambda$  be a partition and let  $\ell \in \mathbf{N}$ . Let  $E$  be the natural representation of  $\mathrm{GL}_2(\mathbf{C})$ . Let  $\rho : \mathrm{GL}_2(\mathbf{C}) \rightarrow \mathrm{GL}(V)$  be the representation corresponding to  $V$ . We define  $\nabla^\lambda \mathrm{Sym}^\ell E$  to be the restriction of the representation  $\nabla^\lambda V$  of  $\mathrm{GL}(V)$  to the image of  $\rho$ .

Let  $v_k = e_1^{\ell-k} e_2^k$  for  $0 \leq k \leq \ell$  be the canonical basis of  $\mathrm{Sym}^\ell E$ . Using this basis in Definition 2.5, the action of  $g \in \mathrm{GL}(E)$  on a GL-polytabloid  $F(s)$  may be computed by the following device: formally replace each entry  $b$  of  $s$  with  $gv_b$ , expressed as a linear combination of  $v_0, v_1, \dots, v_\ell$ . Then expand multilinearly, and use the column relation (2.5) followed by Garnir relations (see [7, Corollary 2.6] or [10, Chapter 8]) to express the result as a linear combination of GL-polytabloids  $F(t)$  for semistandard tableaux  $t$ .

**Example 2.6.** Take  $\ell = 2$  so  $V = \mathrm{Sym}^2 E = \langle e_1^2, e_1 e_2, e_2^2 \rangle$ . The action of a lower-triangular matrix  $g \in \mathrm{GL}_2(\mathbf{C})$  on  $V$  is given, with respect to the chosen basis, by

$$\begin{pmatrix} \alpha & 0 \\ \gamma & \delta \end{pmatrix} \mapsto \begin{pmatrix} \alpha^2 & 0 & 0 \\ 2\alpha\gamma & \alpha\delta & 0 \\ \gamma^2 & \gamma\delta & \delta^2 \end{pmatrix}.$$

In its action on  $\nabla^{(2,1)} \mathrm{Sym}^2 E$  we have

$$\begin{aligned} gF\left(\begin{array}{|c|c|} \hline 0 & 2 \\ \hline 1 & \\ \hline \end{array}\right) &= F\left(\begin{array}{|c|c|} \hline \alpha^2 v_0 + 2\alpha\gamma v_1 + \gamma^2 v_2 & \delta^2 v_2 \\ \hline \alpha\delta v_1 + \gamma\delta v_2 & \\ \hline \end{array}\right) \\ &= \alpha^3 \delta^3 F\left(\begin{array}{|c|c|} \hline 0 & 2 \\ \hline 1 & \\ \hline \end{array}\right) + \alpha^2 \gamma \delta^3 F\left(\begin{array}{|c|c|} \hline 0 & 2 \\ \hline 2 & \\ \hline \end{array}\right) \\ &\quad + 2\alpha\gamma^2 \delta^3 F\left(\begin{array}{|c|c|} \hline 1 & 2 \\ \hline 2 & \\ \hline \end{array}\right) + \alpha\gamma^2 \delta^3 F\left(\begin{array}{|c|c|} \hline 2 & 2 \\ \hline 1 & \\ \hline \end{array}\right) \\ &= \alpha^3 \delta^3 F\left(\begin{array}{|c|c|} \hline 0 & 2 \\ \hline 1 & \\ \hline \end{array}\right) + \alpha^2 \gamma \delta^3 F\left(\begin{array}{|c|c|} \hline 0 & 2 \\ \hline 2 & \\ \hline \end{array}\right) + (2\alpha\gamma^2 \delta^3 - \alpha\gamma^2 \delta^3) F\left(\begin{array}{|c|c|} \hline 1 & 2 \\ \hline 2 & \\ \hline \end{array}\right). \end{aligned}$$

where the third line uses the column relation in (2.5).

**Lemma 2.7.** *Let  $\lambda$  be a partition and let  $\ell \in \mathbf{N}_0$ . We have*

$$\Phi_{\nabla^\lambda \mathrm{Sym}^\ell E}(1, q) = \sum_{t \in \mathrm{SSYT}_{\leq \ell}(\lambda)} q^{|t|}.$$

*Proof.* By Theorem 2.4, the  $F(t)$  for  $t \in \text{SSYT}_{\leq \ell}(\lambda)$  are a basis of  $\nabla^\lambda \text{Sym}^\ell E$ . Let  $g \in \text{GL}_2(\mathbf{C})$  be diagonal with entries  $\alpha$  and  $\delta$ . Let  $\tau \in C(t)$  and let  $u = \tau \cdot t$ . By (2.3),

$$g \cdot f(u) = \bigotimes_{i=1}^{\ell(\lambda)} \prod_{j=1}^{\lambda_i} (g \cdot v_{t(i,j)}).$$

Since  $g \cdot v_k = \alpha^{\ell-k} \delta^k v_k$ , we have  $g \cdot f(u) = \alpha^{|\lambda| - |u|} \delta^{|u|} f(u)$  where  $|u| = \sum_{(i,j) \in [\lambda]} u(i,j)$  is the weight  $|u|$  defined above. This is also the weight of  $t$ . Therefore each  $F(t)$  is an eigenvector for  $g$  with eigenvalue  $\alpha^{|\lambda| - |t|} \delta^{|t|}$ . The lemma follows.  $\square$

**2.5. Symmetric functions and plethysm.** Let  $\mathbf{C}[x_0, x_1, \dots]$  be the polynomial ring in the indeterminates  $x_0, x_1, \dots$ . We define a *symmetric function*  $f$  to be a family  $f^{(n)}(x_0, \dots, x_n)$  of symmetric polynomials in  $\mathbf{C}[x_0, x_1, \dots]$  such that

$$(2.6) \quad f^{(n)}(x_0, \dots, x_m, 0, \dots, 0) = f^{(m)}(x_0, \dots, x_m)$$

for all  $m, n \in \mathbf{N}_0$  with  $m \leq n$ . The notation is simplified (without introducing any ambiguity) by writing  $f(x_0, \dots, x_\ell)$  for  $f^{(\ell)}(x_0, \dots, x_\ell)$ .

**Definition 2.8.** Let  $\lambda$  be a partition. Given a  $\lambda$ -tableau  $t$  with entries from  $\mathbf{N}_0$ , let  $x^t = x_0^{a_0(t)} x_1^{a_1(t)} \dots$  where  $a_k(t)$  is the number of entries of  $t$  equal to  $k \in \mathbf{N}_0$ . The *Schur function*  $s_\lambda$  is the symmetric function defined by

$$s_\lambda(x_0, x_1, \dots, x_\ell) = \sum_{t \in \text{SSYT}_{\leq \ell}(\lambda)} x^t.$$

The compatibility condition (2.6) is easily checked. Let  $\mathbf{C}[q]$  be a polynomial ring. Observe that when  $x_k$  is specialized to  $q^k$ , the monomial  $x^t$  becomes  $q^{|t|}$ , where, as usual,  $|t|$  is the weight of  $t$ . Therefore

$$(2.7) \quad s_\lambda(1, q, \dots, q^\ell) = \sum_{t \in \text{SSYT}_{\leq \ell}(\lambda)} q^{|t|}.$$

It follows immediately from our definition and Lemma 2.7 that

$$(2.8) \quad \Phi_{\nabla^\lambda \text{Sym}^\ell E}(1, q) = s_\lambda(1, q, \dots, q^\ell).$$

This equation is the main bridge we need between representation theory and combinatorics.

**Remark 2.9.** The plethysm product of symmetric functions is defined in [19], [20, Ch. 1, Appendix A] and [29, Ch. 7, Appendix 2]. For our purposes, we may define  $(s_\lambda \circ s_{(\ell)})(x, y)$  by formally substituting the monomials summands of  $s_{(\ell)}(x, y) = x^\ell + x^{\ell-1}y + \dots + y^\ell$  for the  $\ell + 1$  variables in  $s_\lambda(x_0, \dots, x_\ell)$ . That is,  $(s_\lambda \circ s_{(\ell)})(x, y) = s_\lambda(x^\ell, x^{\ell-1}y, \dots, y^\ell)$ . Hence  $\Phi_{\nabla^\lambda \text{Sym}^\ell E}(1, q) = (s_\lambda \circ s_{(\ell)})(1, q)$ , as mentioned after (1.2) earlier.

For Theorem 3.4(i) we require the original definition of Schur polynomials using determinants and antisymmetric polynomials. Given a sequence  $(\gamma_0, \gamma_1, \dots, \gamma_\ell)$  of non-negative integers, define

$$(2.9) \quad a_\gamma(x_0, x_1, \dots, x_\ell) = \det \begin{pmatrix} x_0^{\gamma_0} & x_0^{\gamma_1} & \cdots & x_0^{\gamma_\ell} \\ x_1^{\gamma_0} & x_1^{\gamma_1} & \cdots & x_1^{\gamma_\ell} \\ \vdots & \vdots & \ddots & \vdots \\ x_\ell^{\gamma_0} & x_\ell^{\gamma_1} & \cdots & x_\ell^{\gamma_\ell} \end{pmatrix}.$$

By [29, Theorem 7.15.1], if  $\ell \geq \ell(\gamma) - 1$  then

$$(2.10) \quad s_\lambda(x_0, x_1, \dots, x_\ell) = \frac{a_{\lambda+(\ell, \ell-1, \dots, 0)}(x_0, x_1, \dots, x_\ell)}{a_{(\ell, \ell-1, \dots, 0)}(x_0, x_1, \dots, x_\ell)}.$$

## 2.6. Stanley's Hook Content Formula.

**Definition 2.10.** Let  $\lambda$  be a partition. We define the *minimum weight* of  $\lambda$ , denoted  $b(\lambda)$ , by  $b(\lambda) = \sum_{j=1}^{a(\lambda)} \binom{\lambda'_j}{2}$ .

Equivalently,  $b(\lambda) = \sum_{i=1}^{\ell(\lambda)} (i-1)\lambda_i$ . Observe that  $b(\lambda)$  is the weight of the semistandard  $\lambda$ -tableau having  $\lambda_i$  entries of  $i-1$  in row  $i$ ; as the terminology suggests, this tableau has the minimum weight of any tableau in  $\text{SSYT}_{\leq \ell}(\lambda)$ . It follows that  $q^{b(\lambda)}$  is the summand of  $s_\lambda(1, q, \dots, q^\ell)$  of minimum degree.

**Definition 2.11.** Let  $\lambda$  be a partition. The *hook length* of  $(i, j) \in [\lambda]$ , denoted  $h_{(i,j)}(\lambda)$ , is  $(\lambda_i - i) + (\lambda'_j - j) + 1$ . The *content* of  $(i, j) \in [\lambda]$  is  $j - i$ . Let  $H(\lambda) = \{h_{(i,j)}(\lambda) : (i, j) \in [\lambda]\}$  and  $C(\lambda) = \{j - i : (i, j) \in [\lambda]\}$  be the corresponding multisets.

For example, the unique greatest hook length of a non-empty partition  $\lambda$  is  $h_{(1,1)}(\lambda) = (a(\lambda) - 1) + (\ell(\lambda) - 1) + 1 = a(\lambda) + \ell(\lambda) - 1$ . The least element of  $C(\lambda)$  is  $1 - \ell(\lambda)$ . Therefore whenever  $\ell \geq \ell(\lambda) - 1$  we have  $C(\lambda) + \ell + 1 \subseteq \mathbf{N}$ .

For  $m \in \mathbf{N}$ , let  $[m]_q$  be the *quantum integer* defined by

$$(2.11) \quad [m]_q = \frac{q^m - 1}{q - 1} = 1 + q + \cdots + q^{m-1}.$$

**Theorem 2.12** (Stanley's Hook Content Formula). *Let  $\lambda$  be a partition and let  $\ell \in \mathbf{N}$ . Then*

$$s_\lambda(1, q, \dots, q^\ell) = q^{b(\lambda)} \frac{\prod_{(i,j) \in [\lambda]} [j - i + \ell + 1]_q}{\prod_{(i,j) \in [\lambda]} [h_{(i,j)}(\lambda)]_q}.$$

*Proof.* This is a restatement of [29, Theorem 7.21.2] using the quantum integer notation. Note that our  $\ell$  appears in [29] as  $\ell - 1$ .  $\square$

**2.7. Pyramids.** In this subsection we prove an antisymmetric analogue of Stanley's Hook Content Formula. Most of the ideas may be found in [29, §7.21], so no originality is claimed.

**Definition 2.13.** We define the *differences*  $\delta(\lambda)$  of a partition  $\lambda$  by  $\delta(\lambda)_j = \lambda_j - \lambda_{j+1} + 1$  for each  $j \in \mathbf{N}$ . For  $\ell \geq \ell(\lambda) - 1$ , let  $\Delta_\ell(\lambda)$  be the multiset whose elements are all  $\delta(\lambda)_j + \cdots + \delta(\lambda)_{k-1}$  for  $1 \leq j < k \leq \ell + 1$ .

Observe that if  $j < k$  then  $\lambda_j - \lambda_k + k - j = \delta(\lambda)_j + \cdots + \delta(\lambda)_{k-1}$ .

**Lemma 2.14.** *Let  $\lambda$  be a partition such that  $\ell \geq \ell(\lambda) - 1$ . There exists  $c \in \mathbf{N}_0$  such that*

$$s_\lambda(1, q, \dots, q^\ell) = q^c \frac{\prod_{1 \leq j < k \leq \ell+1} [\delta(\lambda)_j + \cdots + \delta(\lambda)_{k-1}]_q}{\prod_{1 \leq j < k \leq \ell+1} [k-j]_q}.$$

*Proof.* Taking  $\gamma = (0, 1, \dots, \ell)$  in (2.9) and transposing the matrix we get the Vandermonde identity

$$\prod_{0 \leq j < k \leq \ell} (x_j - x_k) = \det \begin{pmatrix} 1 & 1 & \cdots & 1 \\ x_0 & x_1 & \cdots & x_\ell \\ \vdots & \vdots & \ddots & \vdots \\ x_0^\ell & x_1^\ell & \cdots & x_\ell^\ell \end{pmatrix}.$$

By (2.9) we have

$$a_\gamma(1, q, \dots, q^\ell) = \det \begin{pmatrix} 1 & 1 & \cdots & 1 \\ q^{\gamma_0} & q^{\gamma_1} & \cdots & q^{\gamma_\ell} \\ \vdots & \vdots & \ddots & \vdots \\ q^{\ell\gamma_0} & q^{\ell\gamma_1} & \cdots & q^{\ell\gamma_\ell} \end{pmatrix}.$$

Therefore, specializing  $x_j$  to  $q^{\gamma_j}$  in the Vandermonde determinant, we obtain

$$a_\gamma(1, q, \dots, q^\ell) = \prod_{0 \leq j < k \leq \ell} q^{\gamma_k} (q^{\gamma_j - \gamma_k} - 1).$$

Set  $\gamma_j = \lambda_{j+1} + \ell - j$  for  $0 \leq j \leq \ell$ , and use the observation just before the lemma to get

$$a_{\lambda+(\ell, \dots, 1, 0)}(1, q, \dots, q^\ell) = q^{C(\lambda)} \prod_{1 \leq j < k \leq \ell+1} (q^{\delta(\lambda)_j + \cdots + \delta(\lambda)_{k-1}} - 1)$$

for some  $C(\lambda) \in \mathbf{N}_0$ . The special case  $\lambda = \emptyset$  gives the specialized Vandermonde identity

$$a_{(\ell, \dots, 1, 0)} = q^{C(\emptyset)} \prod_{1 \leq j < k \leq \ell+1} (q^{k-j} - 1).$$

Taking the ratio of these two equations and using (2.10) we obtain

$$s_\lambda(1, q, \dots, q^\ell) = q^c \frac{\prod_{1 \leq j < k \leq \ell+1} (q^{\delta(\lambda)_j + \cdots + \delta(\lambda)_{k-1}} - 1)}{\prod_{1 \leq j < k \leq \ell+1} (q^{k-j} - 1)}$$

where  $c = C(\lambda) - C(\emptyset)$ . This is equivalent to the claimed identity.  $\square$

**Corollary 2.15.** *Let  $\lambda$  be a partition and let  $\ell \geq \ell(\lambda) - 1$ . Then*

$$s_\lambda(1, q, \dots, q^\ell) = q^{b(\lambda)} \frac{\prod_{x \in \Delta_\ell(\lambda)} [x]_q}{[1]_q^\ell [2]_q^{\ell-1} \dots [\ell]_q}.$$

*Proof.* By Lemma 2.14 there exists  $c \in \mathbf{N}_0$  such that

$$s_\lambda(1, q, \dots, q^\ell) = q^c \frac{\prod_{1 \leq j < k \leq \ell+1} [\delta(\lambda)_j + \dots + \delta(\lambda)_{k-1}]_q}{\prod_{1 \leq j < k \leq \ell+1} [k-j]_q}.$$

The factors in the numerator are the quantum integers from  $\Delta_\ell(\lambda)$ . The factors in the denominator are the quantum integers from  $\{1^\ell, 2^{\ell-1}, \dots, \ell\}$ , where the exponents indicate multiplicities. By (2.7),  $q^{b(\lambda)}$  is the monomial of least degree in  $s_\lambda(1, q, \dots, q^\ell)$ . Since each quantum integer is congruent to 1 modulo  $q$ , the result follows.  $\square$

It is convenient to display the elements of the multiset  $\Delta_\ell(\lambda)$  in a *pyramid* of  $\ell$  rows, numbered from 1, in which row  $i$  has entries  $\delta(\lambda)_j + \dots + \delta(\lambda)_{j+i-1}$ , for  $j \in \{1, \dots, \ell - (i-1)\}$ . Thus, writing  $P_j^{(i)}$  for the entry in position  $j$  of row  $i$  of the pyramid  $P$ , we have  $P_j^{(i+1)} = P_j^{(i)} + P_{j+1}^{(i)} - P_{j+1}^{(i-1)}$ . By convention, we set  $P_j^{(0)} = 0$  for each  $j$ .

**Example 2.16.** We take  $\ell = m = 5$ . The partitions  $(8, 7, 2, 2)$  and  $(8, 6, 3)$  have differences  $(2, 6, 1, 3, 1)$  and  $(3, 4, 4, 1, 1)$ , respectively. Their pyramids are

$$\begin{array}{ccccc} 2 & 6 & 1 & 3 & 1 \\ 8 & 7 & 4 & 4 & \\ 9 & 10 & 5 & & \\ 12 & 11 & & & \\ 13 & & & & \end{array}, \quad \begin{array}{ccccc} 3 & 4 & 4 & 1 & 1 \\ 7 & 8 & 5 & 2 & \\ 11 & 9 & 6 & & \\ 12 & 10 & & & \\ 13 & & & & \end{array}.$$

Each pyramid has multiset of entries  $\{1^2, 2, 3, 4^2, 5, 6, 7, 8, 9, 10, 11, 12, 13\}$ . By Corollary 2.15, cancelling the equal denominators  $[1]_q^5 [2]_q^4 [3]_q^3 [4]_q^2 [5]_q$  we see that  $s_{(8,7,2,2)}(1, q, q^2, q^3, q^4, q^5)$  and  $s_{(8,6,3)}(1, q, q^2, q^3, q^4, q^5)$  are equal up to a power of  $q$ . By Theorem 3.4(e) below,  $(8, 7, 2, 2)_5 \sim_5 (8, 6, 3)$ .

This example is generalized in Proposition 11.3.

### 3. EQUIVALENT CONDITIONS FOR THE PLETHYSTIC ISOMORPHISM

**3.1. Difference multisets.** The following formalism simplifies the main results of this section and is convenient throughout this paper.

**Definition 3.1.** A *difference multiset* is a pair  $(X, Z)$  of finite multisubsets of  $\mathbf{N}$ , denoted  $X/Z$ . If  $x \in \mathbf{N}$  has multiplicity  $a$  in  $X$  and  $b$  in  $Z$ , then the *multiplicity* of  $x$  in  $X/Z$  is  $a - b$ . Two difference multisets are *equal* if their multiplicities agree for all  $x \in \mathbf{N}$ .

Alternatively, a difference multiset may be regarded as an element of the free abelian group on  $\mathbf{N}$ . This point of view justifies our definition of equality and makes obvious many simple algebraic rules for manipulating difference multisets. For example,  $X/Z = Y/W$  if and only if  $X/Y = Z/W$ .

The following lemma is used implicitly in (4.8) in [18].

**Lemma 3.2.** *Let  $X$  and  $Y$  be finite multisubsets of  $\mathbf{N}$ . In the polynomial ring  $\mathbf{C}[q]$ , we have  $\prod_{x \in X}(q^x - 1) = \prod_{y \in Y}(q^y - 1)$  if and only if  $X = Y$ .*

*Proof.* If either  $X$  or  $Y$  is empty the result is obvious. In the remaining cases, let  $u$  be greatest such that  $\prod_{x \in X}(q^x - 1)$  has  $e^{2\pi i/u}$  as a root. By choice of  $u$ ,  $q^u - 1$  is a factor in the left-hand side. Since  $e^{2\pi i/u}$  is also a root of  $\prod_{y \in Y}(q^y - 1)$ , the same argument shows that  $q^u - 1$  is a factor in the right-hand side. Therefore  $u = \max X = \max Y$  and it follows inductively that  $X = Y$ .  $\square$

**Corollary 3.3.** *Let  $X/Z$  and  $Y/W$  be difference multisets. Working in the field of fractions of  $\mathbf{C}[q]$ , we have*

$$\frac{\prod_{x \in X}(q^x - 1)}{\prod_{z \in Z}(q^z - 1)} = \frac{\prod_{y \in Y}(q^y - 1)}{\prod_{w \in W}(q^w - 1)}$$

*if and only if  $X/Z = Y/W$ .*

*Proof.* Multiply through by  $\prod_{z \in Z}(q^z - 1) \prod_{w \in W}(q^w - 1)$  and then apply Lemma 3.2.  $\square$

We apply this corollary to the polynomial quotients in Theorem 2.12 and Corollary 2.15 in the proof of Theorem 3.4 below.

**3.2. Portmanteau Theorem.** Recall from §2.3 that the weight of a tableau, denoted  $|t|$ , is its sum of entries. The minimum weight  $b(\lambda)$  is defined in Definition 2.10. Given a partition  $\lambda$  and  $\ell \in \mathbf{N}_0$ , let  $\mathcal{S}_e^\ell(\lambda)$  be the set of all semistandard  $\lambda$ -tableaux with entries from  $\{0, 1, \dots, \ell\}$  whose weight is  $e$ . Thus (2.7) can be restated as

$$(3.1) \quad s_\lambda(1, q, \dots, q^\ell) = \sum_{e \in \mathbf{N}_0} |\mathcal{S}_e^\ell(\lambda)| q^e.$$

In (h) and (i) below the notation indicates a difference multiset, as defined in the previous subsection. The multisets  $C(\lambda)$  and  $H(\lambda)$  are defined in Definition 2.11 and  $\Delta_\ell(\lambda)$  is defined in Definition 2.13.

**Theorem 3.4.** *Let  $\lambda$  and  $\mu$  be partitions and let  $\ell, m \in \mathbf{N}$  be such that  $\ell \geq \ell(\lambda) - 1$  and  $m \geq \ell(\mu) - 1$ . The following are equivalent:*

- (a)  $\lambda \underset{\ell}{\sim} \mu$ ;
- (b)  $\nabla^\lambda \text{Sym}^\ell E \cong \nabla^\mu \text{Sym}^m E$  as representations of  $\text{SL}_2(\mathbf{C})$ ;
- (c)  $\Psi_{\nabla^\lambda \text{Sym}^\ell E}(Q) = \Psi_{\nabla^\mu \text{Sym}^m E}(Q)$ ;
- (d)  $q^{-\ell|\lambda|/2} s_\lambda(1, q, \dots, q^\ell) = q^{-m|\mu|/2} s_\mu(1, q, \dots, q^m)$ ;

- (e)  $s_\lambda(1, q, \dots, q^\ell) = q^d s_\mu(1, q, \dots, q^m)$  for some  $d \in \mathbf{Z}$ ;
- (f)  $q^{-b(\lambda)} s_\lambda(1, q, \dots, q^\ell) = q^{-b(\mu)} s_\mu(1, q, \dots, q^m)$ ;
- (g) there exists  $d \in \mathbf{Z}$  such that  $|\mathcal{S}_{e+d}^\ell(\lambda)| = |\mathcal{S}_e^m(\mu)|$  for all  $e \in \mathbf{N}_0$ ;
- (h)  $(C(\lambda) + \ell + 1)/H(\lambda) = (C(\mu) + m + 1)/H(\mu)$ ;
- (i)  $\Delta_\ell(\lambda)/\{1^\ell, 2^{\ell-1}, \dots, \ell\} = \Delta_m(\mu)/\{1^m, 2^{m-1}, \dots, m\}$ .

Moreover if any of these conditions hold then  $-\frac{\ell|\lambda|}{2} + b(\lambda) = -\frac{m|\mu|}{2} + b(\mu)$ , each side in (d) is unimodal and centrally symmetric about its constant term, and the constant  $d$  in (e) and (g) is  $b(\lambda) - b(\mu)$ .

*Proof.* By Definition 1.1, (a) and (b) are equivalent. By Lemma 2.2, (b) and (c) are equivalent. By definition  $\Psi_{\nabla^\lambda \text{Sym}^\ell E}(Q) = \Phi_{\nabla^\lambda \text{Sym}^\ell E}(Q^{-1}, Q)$ . Hence, by (2.8) and the homogeneity of  $\nabla^\lambda \text{Sym}^\ell E$ ,

$$\Phi_{\nabla^\lambda \text{Sym}^\ell E}(q^{-1/2}, q^{1/2}) = q^{-\ell|\lambda|/2} s_\lambda(1, q, \dots, q^\ell).$$

Therefore (c) and (d) are equivalent. Clearly (d) implies (e). Conversely, suppose that (e) holds, with  $q^d s_\lambda(1, q, \dots, q^\ell) = s_\mu(1, q, \dots, q^m)$ . By the previous displayed equation and Lemma 2.2,  $q^{-\ell|\lambda|/2} s_\lambda(1, q, \dots, q^\ell)$  is a linear combination of polynomials of the form  $q^{-b/2} + q^{-(b-1)/2} + \dots + q^{b/2}$ . Hence it is centrally symmetric and unimodal about its constant term. Now, comparing points of central symmetry, (e) implies that  $d + \ell|\lambda|/2 = m|\mu|/2$ . Multiplying both sides of  $q^d s_\lambda(1, q, \dots, q^\ell) = s_\mu(1, q, \dots, q^m)$  by  $q^{-d-\ell|\lambda|/2} = q^{-m|\mu|/2}$ , we obtain (d). We noted before Definition 2.11 that  $s_\lambda(1, q, \dots, q^\ell)$  has minimum degree summand  $q^{b(\lambda)}$ . Therefore (e) and (f) are equivalent. By (3.1), (e) and (g) are equivalent. The remainder of the ‘moreover’ part now follows by comparing the  $q$  powers in (d) and (f). By Stanley’s Hook Content Formula, as stated in Theorem 2.12, (f) holds if and only if

$$\frac{\prod_{(i,j) \in [\lambda]} [j - i + \ell + 1]_q}{\prod_{(i,j) \in [\lambda]} [h_{(i,j)}(\lambda)]_q} = \frac{\prod_{(i,j) \in [\mu]} [j - i + m + 1]_q}{\prod_{(i,j) \in [\mu]} [h_{(i,j)}(\mu)]_q}.$$

By Corollary 3.3, this is equivalent to (h). Finally (f) and (i) are equivalent by the same argument with Corollary 3.3 applied to the right-hand side in Corollary 2.15.  $\square$

**3.3. Extending plethystic isomorphisms.** We end by considering when an  $\text{SL}_2(\mathbf{C})$ -isomorphism  $\nabla^\lambda \text{Sym}^\ell E \cong \nabla^\mu \text{Sym}^m E$  extends to an overgroup of  $\text{SL}_2(\mathbf{C})$ . The following lemma is used to show that the only obstruction is the determinant representation of  $\text{GL}(E)$ .

**Lemma 3.5.** *Let  $\lambda$  and  $\mu$  be partitions and let  $\ell, m \in \mathbf{N}$  be such that  $\ell \geq \ell(\lambda) - 1$  and  $m \geq \ell(\mu) - 1$  and  $\lambda \underset{\ell}{\sim} \mu$ . Set  $D = -\frac{\ell|\lambda|}{2} + \frac{m|\mu|}{2}$ . Then  $D \in \mathbf{Z}$  and*

$$\det^D \otimes \nabla^\lambda \text{Sym}^\ell E \cong \nabla^\mu \text{Sym}^m E$$

*as representations of  $\text{GL}_2(\mathbf{C})$ .*



*Proof.* By the ‘moreover’ part in Theorem 3.4,  $D = -b(\lambda) + b(\mu)$ , and hence  $D \in \mathbf{Z}$ . By (2.8), we have  $s_\lambda(1, q, \dots, q^\ell) = \Phi_{\nabla^\lambda \text{Sym}^\ell E}(1, q)$ . Therefore

$$(3.2) \quad q^D \Phi_{\nabla^\lambda \text{Sym}^\ell E}(1, q) = \Phi_{\nabla^\mu \text{Sym}^m E}(1, q).$$

Since representations of  $\text{GL}_2(\mathbf{C})$  are completely reducible, they are determined by their characters. Since  $\Phi_{\det}(\alpha, \beta) = \alpha\beta$ , the  $\text{GL}_2(\mathbf{C})$  representations  $\det^D \otimes \nabla^\lambda \text{Sym}^\ell E$  and  $\nabla^\mu \text{Sym}^m E$  are isomorphic if and only if

$$(\alpha\beta)^D \Phi_{\nabla^\lambda \text{Sym}^\ell E}(\alpha, \beta) = \Phi_{\nabla^\mu \text{Sym}^m E}(\alpha, \beta)$$

for all  $\alpha, \beta \in \mathbf{C}^\times$ . Since  $\Phi_{\nabla^\lambda \text{Sym}^\ell E}$  is homogeneous of degree  $\ell|\lambda|$  and  $\Phi_{\nabla^\mu \text{Sym}^m E}$  is homogeneous of degree  $m|\mu|$ , this holds if and only if

$$(\alpha\beta)^D \alpha^{\ell|\lambda|} \Phi_{\nabla^\lambda \text{Sym}^\ell E}(1, \beta/\alpha) = \alpha^{m|\mu|} \Phi_{\nabla^\mu \text{Sym}^m E}(1, \beta/\alpha).$$

for all  $\alpha, \beta \in \mathbf{C}^\times$ . Using (3.2) to rewrite  $\Phi_{\nabla^\mu \text{Sym}^m E}(1, \beta/\alpha)$  on the right-hand side we get the equivalent condition that  $(\alpha\beta)^D \alpha^{\ell|\lambda|} = \alpha^{m|\mu|} (\beta/\alpha)^D$  for all  $\alpha, \beta \in \mathbf{C}^\times$ . This holds by our choice of  $D$ .  $\square$

For  $d \in \mathbf{N}_0$ , let  $U_d = \{\omega \in \mathbf{C} : \omega^d = 1\}$  and let

$$\text{MGL}_2^{(d)}(\mathbf{C}) = \{g \in \text{GL}_2(\mathbf{C}) : \det g \in U_d\}.$$

If  $\text{SL}_2(\mathbf{C}) \leq G \leq \text{GL}_2(\mathbf{C})$  then either  $\{\det g : g \in G\}$  is one of the subgroups  $U_d$  or it is dense (in the Zariski topology) on  $\mathbf{C}^\times$ . In the latter case, if  $V$  and  $W$  are polynomial representations of  $\text{GL}_2(\mathbf{C})$  and  $V \cong W$  as representations of  $\text{SL}_2(\mathbf{C})$ , then the isomorphism extends to  $G$  if and only if it extends to  $\text{GL}_2(\mathbf{C})$ .

**Proposition 3.6.** *Let  $\lambda$  and  $\mu$  be partitions and let  $\ell, m \in \mathbf{N}$  be such that  $\ell \geq \ell(\lambda) - 1$  and  $m \geq \ell(\mu) - 1$ . Suppose that  $\lambda \ell \sim_m \mu$ . Set  $D = -\frac{\ell|\lambda|}{2} + \frac{m|\mu|}{2}$ . Then  $D \in \mathbf{Z}$  and  $\nabla^\lambda \text{Sym}^\ell E$  is isomorphic to  $\nabla^\mu \text{Sym}^m E$  as representations of  $\text{MGL}_2^{(d)}(\mathbf{C})$  if and only if  $d$  divides  $D$ .*

*Proof.* By Lemma 3.5, we have the required isomorphism if and only if  $\det^D$  is the trivial representation of  $\text{MGL}_2^{(d)}(\mathbf{C})$ . This holds if and only if  $U_d$  has exponent dividing  $D$ , so if and only if  $d$  divides  $D$ .  $\square$

In particular,  $\nabla^\lambda \text{Sym}^\ell E$  and  $\nabla^\mu \text{Sym}^m E$  are isomorphic as representations of  $\text{GL}_2(\mathbf{C})$  if and only if they are isomorphic as representations of  $\text{SL}_2(\mathbf{C})$  and the degrees  $\ell|\lambda|$  and  $m|\mu|$  are equal. This is Theorem 3.1(ii) in [3], which our Proposition 3.6 extends.

It is worth noting that the proof of Lemma 3.5 made essential use of the fact that the representations involved are homogeneous. For example, if  $V = \det \oplus \det^2$  and  $W = E \otimes \det$  then  $\Phi_V(1, q) = \Phi_W(1, q) = q + q^2$ . But  $V$  and  $W$  are not isomorphic, even after restriction to  $\text{SL}_2(\mathbf{C})$ .

## 4. BASIC PROPERTIES OF EQUIVALENCE

Given a non-empty partition  $\lambda$  let  $\bar{\lambda}$  be the partition obtained by removing all columns of length  $\ell(\lambda)$  from  $\lambda$ .

**Lemma 4.1.** *If  $\lambda$  is a partition then either  $\bar{\lambda}$  is empty or  $\lambda_{\ell(\lambda)-1} \sim_{\ell(\lambda)-1} \bar{\lambda}$ .*

*Proof.* Let  $\ell = \ell(\lambda) - 1$  and suppose that  $\lambda$  has precisely  $c$  columns of length  $\ell(\lambda)$ . We may suppose that  $a(\lambda) > c$ . If  $t$  is a semistandard tableau of shape  $\lambda$  with entries from  $\{0, 1, \dots, \ell\}$  then the first  $c$  columns of  $t$  each have entries  $0, 1, \dots, \ell$  read from top to bottom. Let  $\bar{t}$  be the tableau obtained from  $t$  by removing these columns. Using the model for  $\nabla^\lambda \text{Sym}^\ell E$  in Definition 2.5, we see that there is a linear isomorphism  $\phi : \nabla^\lambda \text{Sym}^\ell E \rightarrow \nabla^{\bar{\lambda}} \text{Sym}^\ell E$  defined by  $F(t) \mapsto F(\bar{t})$ . Moreover, by a routine generalization of Example 2.3, if  $h \in \text{GL}(\text{Sym}^\ell E)$  then

$$\phi(hF(t)) = (\det h)^c h\phi(F(t)).$$

If  $g \in \text{GL}(E)$ , each matrix coefficient of  $g$  in its action on  $\text{Sym}^\ell E$  is a polynomial of degree  $\ell$ , and so the determinant of  $g$  acting on  $\text{Sym}^\ell E$  has degree  $\ell(\ell + 1)$ . We deduce that  $\phi$  is an isomorphism

$$\nabla^\lambda \text{Sym}^\ell E \cong (\det E)^{c\ell(\ell+1)/2} \otimes \nabla^{\bar{\lambda}} \text{Sym}^\ell E$$

of representations of  $\text{GL}(E)$ . Hence by Theorem 3.4(b), we have  $\lambda_{\ell} \sim_{\ell} \bar{\lambda}$ , as required.  $\square$

An alternative, but we believe less conceptual, proof of Lemma 4.1 can be given by applying Theorem 3.4(g) to the bijection  $t \mapsto \bar{t}$ .

When  $\ell \neq m$  the relation  $_{\ell} \sim_m$  is neither reflexive nor transitive. The following lemma is the correct replacement for transitivity.

**Lemma 4.2.** *Let  $k, \ell, m \in \mathbf{N}$  and let  $\lambda, \mu, \nu$  be partitions. If  $\lambda_k \sim_{\ell} \mu$  and  $\mu_{\ell} \sim_m \nu$  then  $\lambda_k \sim_m \nu$ .*

*Proof.* This is immediate from Theorem 3.4(b).  $\square$

**Proposition 4.3.** *Let  $\lambda$  and  $\mu$  be partitions. Then  $\lambda_{\ell(\lambda)-1} \sim_{\ell(\mu)-1} \mu$  if and only if  $\bar{\lambda}_{\ell(\lambda)-1} \sim_{\ell(\mu)-1} \bar{\mu}$ .*

*Proof.* This is immediate from Lemma 4.1 and Lemma 4.2.  $\square$

**Lemma 4.4.** *Let  $\lambda$  and  $\mu$  be partitions and let  $\ell, m \in \mathbf{N}$  be such that  $\ell \geq \ell(\lambda) - 1$  and  $m \geq \ell(\mu) - 1$ . Let  $\lambda^*$  and  $\mu^*$  be the partitions obtained from  $\lambda$  and  $\mu$  by removing all columns of length  $\ell + 1$  and  $m + 1$ , respectively. If  $\lambda_{\ell} \sim_m \mu$  then  $\lambda^*$  and  $\mu^*$  have the same number of removable boxes.*

*Proof.* If  $\ell = \ell(\lambda) - 1$  then  $\lambda^* = \bar{\lambda}$  and by Lemma 4.1  $\lambda_{\ell} \sim_{\ell} \lambda^*$ . Otherwise  $\ell > \ell(\lambda) - 1$  and  $\lambda = \lambda^*$ . Hence  $\lambda_{\ell} \sim_{\ell} \lambda^*$  and  $\mu_m \sim_m \mu^*$ . By Lemma 4.2,  $\lambda^*_{\ell} \sim_m \mu^*$ . By Theorem 3.4(g) and the final statement in this theorem,

$$|\mathcal{S}_{b(\lambda)+1}^{\ell}(\lambda^*)| = |\mathcal{S}_{b(\mu)+1}^m(\mu^*)|.$$

For each removable box in  $\lambda^*$ , there is a corresponding semistandard tableau of shape  $\lambda^*$  and weight  $b(\lambda^*) + 1$ , obtained from the unique semistandard tableau of shape  $\lambda^*$  and minimal weight  $b(\lambda^*)$  by increasing the entry in the removable box by 1. Conversely, every element of  $\mathcal{S}_{b(\lambda^*)}^\ell(\lambda^*)$  arises in this way. A similar result holds for  $\mu^*$ . The displayed equation therefore implies that the numbers of removable boxes are the same.  $\square$

**Lemma 4.5.** *Let  $\lambda$  be a non-empty partition and let  $\ell, m \in \mathbf{N}$  be such that  $\ell, m \geq \ell(\lambda) - 1$ . Then  $\lambda \underset{\ell}{\sim}_m \lambda$  if and only if  $\ell = m$ .*

*Proof.* By Theorem 3.4(h) we have  $(C(\lambda) + \ell + 1)/H(\lambda) = (C(\lambda) + m + 1)/H(\lambda)$ . Cancelling the equal sets of hook lengths we have  $C(\lambda) + \ell + 1 = C(\lambda) + m + 1$ . Since  $\lambda$  is non-empty it follows that  $\ell = m$ .  $\square$

Recall that  $a(\lambda)$  denotes the first part of a partition  $\lambda$ .

**Lemma 4.6.** *Let  $\lambda$  be a partition and let  $\ell \in \mathbf{N}$  be such that  $\ell \geq \ell(\lambda)$ . The unique greatest element of  $C(\lambda) + \ell + 1$  is  $a(\lambda) + \ell$ .*

*Proof.* The box  $(1, a(\lambda))$  of  $[\lambda]$  has the unique greatest content of any box in  $\lambda$ , namely of  $a(\lambda) - 1$ .  $\square$

Recall that a plethystic equivalence  $\lambda \underset{\ell}{\sim}_m \mu$  is *prime* if  $\ell \geq \ell(\lambda)$  and  $m \geq \ell(\mu)$ .

**Proposition 4.7.** *Let  $\lambda$  and  $\mu$  be partitions. If  $\lambda \underset{\ell}{\sim}_m \mu$  is a prime equivalence then  $a(\lambda) + \ell = a(\mu) + m$ .*

*Proof.* Since the hypothesised equivalence is prime,  $\ell(\lambda) \leq \ell$  and  $\ell(\mu) \leq m$ . Hence each hook length of  $\lambda$  is at most  $a(\lambda) + \ell - 1$ , and similarly for  $\mu$ . By Lemma 4.6, the unique greatest element of  $(C(\lambda) + \ell + 1)/H(\lambda)$  is  $a(\lambda) + \ell$ , and similarly for  $\mu$ . The lemma now follows from Theorem 3.4(h).  $\square$

## 5. CONJUGATE PARTITIONS

**5.1. Background.** The *rank* of a non-empty partition  $\lambda$ , denoted  $R(\lambda)$ , is the maximum  $r$  such that  $\lambda_r \geq r$ . The *Durfee square* of  $\lambda$  is the subset  $\{(i, j) : 1 \leq i, j \leq R(\lambda)\}$  of its Young diagram. Theorem 1.3 also requires the following less standard definitions.

**Definition 5.1.** Let  $\lambda$  be a partition and let  $d = R(\lambda)$ .

- (i) The *south-rank* of  $\lambda$ , denoted  $S(\lambda)$ , is the maximum  $j \in \mathbf{N}_0$  such that  $\lambda_{d+j} = d$ .
- (ii) The *south-partition* of  $\lambda$ , denoted  $\mathcal{SP}(\lambda)$  is  $(\lambda_{d+S(\lambda)+1}, \dots, \lambda_{\ell(\lambda)})$ .
- (iii) The *east-rank* of  $\lambda$ , denoted  $E(\lambda)$ , is  $S(\lambda')$ .
- (iv) The *east-partition* of  $\lambda$ , denoted  $\mathcal{EP}(\lambda)$ , is  $\mathcal{SP}(\lambda)'$ .

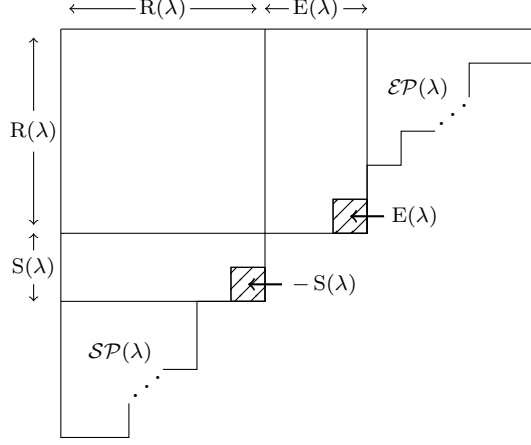

FIGURE 1. The statistics  $R(\lambda)$ ,  $E(\lambda)$ ,  $S(\lambda)$  and partitions  $\mathcal{EP}(\lambda)$ ,  $\mathcal{SP}(\lambda)$ . Two boxes have their content indicated.

These quantities are shown in Figure 1. For example, the partition  $\lambda = (8, 6, 5, 3, 3, 1)$  shown in Figure 2 has  $R(\lambda) = 3$ ,  $E(\lambda) = 2$ ,  $\mathcal{EP}(\lambda) = (3, 1)$ ,  $S(\lambda) = 2$  and  $\mathcal{SP}(\lambda) = (1)$ .

We begin with three equivalent conditions for the existence of infinitely many plethystic equivalences between distinct partitions  $\lambda$  and  $\mu$ . We then prove a fourth equivalent condition, namely that  $\mu = \lambda'$  and  $\mathcal{EP}(\lambda) = \mathcal{SP}(\lambda)'$ , obtaining Theorem 5.5 and, *a fortiori*, Theorem 1.3.

**Proposition 5.2.** *Let  $\lambda$  and  $\mu$  be non-empty partitions. The following are equivalent.*

- (i) *There exist infinitely many pairs  $(\ell, m)$  such that  $\lambda_{\ell} \sim_m \mu$ .*
- (ii) *There exists  $\ell^{\dagger} \geq a(\lambda) + 2(\ell(\lambda) - 1)$  and  $m^{\dagger} \geq a(\mu) + 2(\ell(\mu) - 1)$  such that  $\lambda_{\ell^{\dagger}} \sim_{m^{\dagger}} \mu$ .*
- (iii)  *$H(\lambda) = H(\mu)$  and there exists  $d \in \mathbf{Z}$  such that  $C(\lambda) + d = C(\mu)$ .*

*Proof.* Suppose (i) holds. By Theorem 3.4(h), there exist arbitrarily large  $\ell$  such that, for some  $m$ ,

$$(5.1) \quad (C(\lambda) + \ell + 1)/H(\lambda) = (C(\mu) + m + 1)/H(\mu).$$

When  $\ell$  is very large  $C(\lambda) + \ell + 1$  is disjoint from  $H(\lambda)$ , and by Lemma 4.6 the greatest element with non-zero multiplicity in the left-hand side is  $a(\lambda) + \ell$ . Hence  $m$  is also very large and (ii) holds. If  $\ell^{\dagger}$  and  $m^{\dagger}$  satisfy (ii) then, by (5.1),  $\min(C(\lambda) + \ell^{\dagger} + 1) = -\ell(\lambda) + \ell^{\dagger} + 2 > a(\lambda) + \ell(\lambda) - 1 = \max H(\lambda)$ , and similarly  $\min(C(\mu) + m^{\dagger} + 1) > \max H(\mu)$ . Hence, the multisets  $C(\lambda) + \ell^{\dagger} + 1$  and  $H(\lambda)$  are disjoint, as are the multisets  $C(\mu) + m^{\dagger} + 1$  and  $H(\mu)$ , and so we have  $H(\lambda) = H(\mu)$  and  $C(\lambda) + \ell^{\dagger} + 1 = C(\mu) + m^{\dagger} + 1$ . Moreover, comparing minimum elements in (5.1) we have

$$-\ell(\lambda) + \ell^{\dagger} = -\ell(\mu) + m^{\dagger}.$$

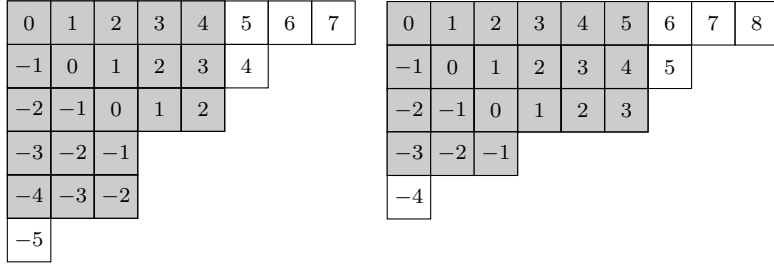

FIGURE 2. The content of the partition obtained from  $\lambda$  by deleting a part of size  $R(\lambda)$  and inserting it as a new column is  $C(\lambda)+1$  is obtained by adding 1 to the content of each box of  $[\lambda]$ ; this can be seen here by comparing the shaded and unshaded boxes.

Hence (iii) holds taking  $d = \ell^\dagger - m^\dagger$ . Finally if (iii) holds, then (i) holds whenever  $\ell - m = d$ . □

We remark that the bound in (ii) is tight: for example, by the Hermite reciprocity seen in §1.2, if  $\lambda = (n)$  and  $\mu = (n + 1)$  where  $n \in \mathbf{N}$ , then  $\lambda \underset{n+1}{\sim} \mu$  and  $n + 1 \geq a(\lambda) + 2(\ell(\lambda) - 1) = n$ . As expected from (ii),  $n \not\geq a(\mu) + 2(\ell(\mu) - 1) = n + 1$ .

Work of Craven [6] shows that there is no simple characterization of when  $H(\lambda) = H(\mu)$ . Fortunately the second condition in (iii) is much more tractable.

**Lemma 5.3.** *Let  $\lambda$  and  $\mu$  be non-empty partitions and let  $d \in \mathbf{Z}$ . Then  $C(\lambda) + d = C(\mu)$  if and only if  $R(\lambda) = R(\mu)$ ,  $\mathcal{EP}(\lambda) = \mathcal{EP}(\mu)$ ,  $\mathcal{SP}(\lambda) = \mathcal{SP}(\mu)$  and*

$$d = -E(\lambda) + E(\mu) = S(\lambda) - S(\mu).$$

*Proof.* The ‘if’ direction is implied by the special case when  $E(\mu) = E(\lambda) + 1$  and  $S(\mu) = S(\lambda) - 1$ . In this case  $\mu$  is obtained from  $\lambda$  by deleting the lowest of the  $S(\lambda)$  parts of  $\lambda$  of size  $R(\lambda)$  and inserting  $R(\lambda)$  boxes as a new column at the right of the  $E(\lambda)$  columns of  $\lambda$  of size  $R(\lambda)$ . We must show that  $C(\mu) = C(\lambda) + 1$ . It is clear that adding 1 to the content of the boxes  $(i, j) \in [\lambda]$  with  $i > R(\lambda) + S(\lambda)$  or  $j > R(\lambda) + E(\lambda)$  gives the content of a corresponding box  $(i - 1, j)$  or  $(i, j + 1) \in [\mu]$ . Moreover, as the shaded squares in Figure 2 show in a special case, adding 1 to the content of each remaining box in  $[\lambda]$  gives the contents of the remaining boxes in  $[\mu]$ .

Conversely, suppose that  $C(\lambda) + d = C(\mu)$ . It is clear that no member of  $C(\lambda)$  can have multiplicity exceeding  $R(\lambda)$ . As can be seen from the content of the two marked boxes in Figure 1, the contents of multiplicity  $R(\lambda)$  are precisely  $-S(\lambda), \dots, E(\lambda)$ . Similarly in  $C(\mu)$  the contents of maximum multiplicity are  $-S(\mu), \dots, E(\mu)$ , each with multiplicity  $R(\mu)$ . Therefore  $R(\lambda) = R(\mu)$ ,  $E(\lambda) + d = E(\mu)$  and  $-S(\lambda) + d = -S(\mu)$ .

The greatest element of  $C(\lambda) + d$  is  $R(\lambda) + E(\lambda) + a(\mathcal{EP}(\lambda)) - 1 + d$  and the greatest element of  $C(\mu)$  is  $R(\mu) + E(\mu) + a(\mathcal{EP}(\mu)) - 1$ . Since  $R(\lambda) = R(\mu)$  and  $E(\lambda) + d = E(\mu)$  it follows that  $a(\mathcal{EP}(\lambda)) = a(\mathcal{EP}(\mu))$ . Similarly comparing  $C(\lambda) + d$  and  $C(\mu)$  on their least elements shows that  $\ell(\mathcal{SP}(\lambda)) = \ell(\mathcal{SP}(\mu))$ . Let  $\lambda^*$  and  $\mu^*$  be the partitions obtained by removing both the first row and column from  $\lambda$  and  $\mu$ , respectively. In each case this removes one box of each content between the least and greatest. Therefore the hypothesis  $C(\lambda) + d = C(\mu)$  implies that  $C(\lambda^*) + d = C(\mu^*)$ . If both sides are empty, we are done. Otherwise, it follows by induction that  $\mathcal{EP}(\lambda^*) = \mathcal{EP}(\mu^*)$  and  $\mathcal{SP}(\lambda^*) = \mathcal{SP}(\mu^*)$ , and hence  $\mathcal{EP}(\lambda) = \mathcal{EP}(\mu)$  and  $\mathcal{SP}(\lambda) = \mathcal{SP}(\mu)$ , as required.  $\square$

**Lemma 5.4.** *Let  $\lambda$  and  $\mu$  be partitions such that  $R(\lambda) = R(\mu)$ . Suppose that for some  $d \in \mathbf{N}$ , we have  $d = -E(\lambda) + E(\mu) = S(\lambda) - S(\mu)$ ,  $\mathcal{EP}(\lambda) = \mathcal{EP}(\mu)$  and  $\mathcal{SP}(\lambda) = \mathcal{SP}(\mu)$ . Then  $H(\lambda) = H(\mu)$  if and only if  $E(\lambda) = S(\mu)$  and  $\mathcal{SP}(\lambda) = \mathcal{EP}(\lambda)'$ .*

*Proof.* Let  $R = R(\lambda)$ ,  $E = E(\lambda)$ ,  $S = S(\mu)$ ,  $\kappa = \mathcal{EP}(\lambda)$  and  $\nu = \mathcal{SP}(\lambda)$ . Figure 3 shows the partitions  $\lambda$  and  $\mu$ . Clearly if  $E = S$  and  $\kappa = \nu'$  then  $\lambda' = \mu$  and so  $H(\lambda) = H(\mu)$ . Conversely, suppose that  $H(\lambda) = H(\mu)$ . The hook lengths outside the two thick rectangles in Figure 3 agree. If  $(i, j)$  is a box in the Durfee square of  $\lambda$  then

$$h_{(i,j)}(\lambda) = (R - j + E + \kappa_i) + (R - i + d + S + \nu'_j) + 1$$

where the parentheses indicate the arm and leg lengths. Similarly if  $(i, j)$  is in a box in the Durfee square of  $\mu$  then

$$h_{(i,j)}(\mu) = (R - j + d + E + \kappa_i) + (R - i + S + \nu'_j) + 1.$$

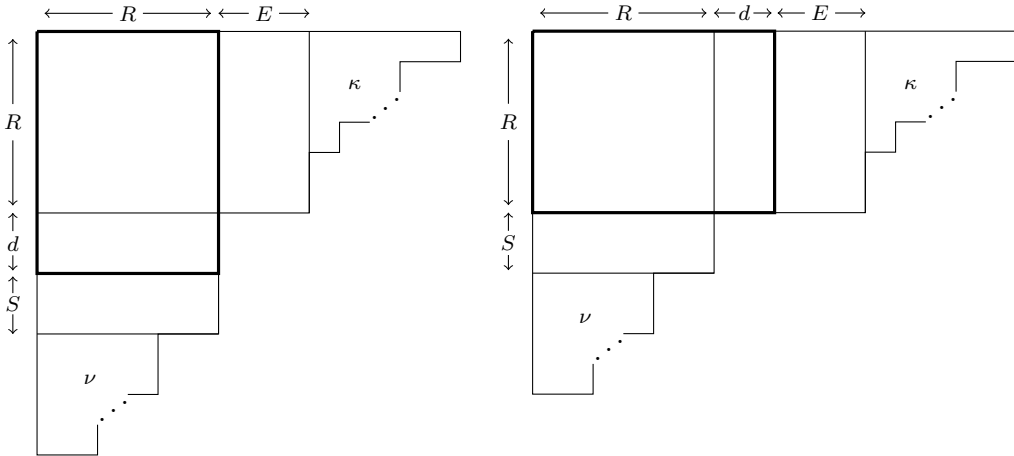

FIGURE 3. The partitions  $\lambda$  and  $\mu$  in Lemma 5.4.

Hence  $h_{(i,j)}(\lambda) = h_{(i,j)}(\mu)$ . It remains to compare the hook lengths

$$\begin{aligned} h_{(R+i,j)}(\lambda) &= (R-j) + (S-i+d+\nu'_j) + 1 \\ h_{(i,R+j)}(\mu) &= (E-j+d+\kappa_i) + (R-i) + 1 \end{aligned}$$

for  $(R+i, j) \in \{R+1, \dots, R+d\} \times \{1, \dots, R\}$  and  $(i, R+j) \in \{1, \dots, R\} \times \{R+1, \dots, R+d\}$ . Since  $R > a(\nu)$  and  $R > \ell(\kappa)$ , the least such hook length for  $\lambda$  is  $h_{(R+d,R)}(\lambda) = S+1$  and the least such hook length for  $\mu$  is  $h_{(R,R+d)}(\mu) = E+1$ . Therefore  $E = S$ . Subtracting  $R+S+d+1$  from the multisets of  $dR$  hook lengths in the two previous displayed equations, we see that  $H(\lambda) = H(\mu)$  if and only if there is an equality of multisets

$$\begin{aligned} &\{\nu'_j - i - j : (R+i, j) \in \{R+1, \dots, R+d\} \times \{1, \dots, R\}\} \\ &= \{\kappa_i - i - j : (i, R+j) \in \{1, \dots, R\} \times \{R+1, \dots, R+d\}\}. \end{aligned}$$

The unique greatest elements of each side are  $\nu'_1 - 2$  and  $\kappa_1 - 2$ , respectively. Therefore  $\nu'_1 = \kappa_1$ . Cancelling the equal sets

$$\begin{aligned} &\{\nu'_1 - i - j : i \in \{1, \dots, d\}, j \in \{1, \dots, R\}\} \\ &\{\kappa_1 - i - j : i \in \{1, \dots, R\}, j \in \{1, \dots, d\}\} \end{aligned}$$

from each side we may repeat this argument inductively, as in the proof of Lemma 5.3, to get  $\nu' = \kappa$ , as required.  $\square$

We are now ready to prove the slightly stronger version of Theorem 1.3 stated below.

**Theorem 5.5.** *Let  $\lambda$  and  $\mu$  be distinct non-empty partitions. The following are equivalent:*

- (i) *there exist infinitely many pairs  $(\ell, m)$  such that  $\lambda \ell \sim_m \mu$ ;*
- (ii)  *$H(\lambda) = H(\mu)$  and there exists  $d \in \mathbf{Z}$  such that  $C(\lambda) + d = C(\mu)$ ;*
- (iii)  *$\lambda = \mu'$  and  $\mathcal{SP}(\lambda) = \mathcal{EP}(\lambda)'$ .*

*Moreover, if any of these condition holds then  $\lambda \ell \sim_m \mu$  if and only if  $\ell = \ell(\lambda) - 1 + k$  and  $m = \ell(\mu) - 1 + k$  for some  $k \in \mathbf{N}_0$  and in (ii)  $d = \ell(\lambda) - \ell(\mu)$ . Finally, if  $\lambda = \mu'$  but  $\mathcal{SP}(\lambda) \neq \mathcal{EP}(\lambda)'$  then there are no plethystic equivalences between  $\lambda$  and  $\mu$ .*

*Proof of Theorem 5.5.* By Proposition 5.2, (i) and (ii) are equivalent. Suppose that (ii) holds. By swapping  $\lambda$  and  $\mu$  if necessary, we may suppose that  $d \in \mathbf{N}_0$ . Since  $\lambda$  and  $\mu$  are distinct and so  $C(\lambda) \neq C(\mu)$ , we have  $d \in \mathbf{N}$ . Now by Lemma 5.3 followed by Lemma 5.4 we get  $\lambda' = \mu$  and  $\mathcal{SP}(\lambda) = \mathcal{EP}(\lambda)'$ , as required. Conversely, these lemmas show that (iii) implies (ii) with  $d = \ell(\lambda) - \ell(\mu)$ . For the ‘moreover’ part, assuming (ii), it follows from Theorem 3.4(h) that  $\lambda \ell \sim_m \mu$  whenever  $\ell \geq \ell(\lambda) - 1$ ,  $m \geq \ell(\mu) - 1$  and  $\ell - m = d$ , giving the claimed plethystic equivalences. Conversely, suppose that  $\lambda \ell \sim_m \mu$  and that (iii) holds. By Proposition 4.7 and (iii), we

have

$$\ell - m = a(\mu) - a(\lambda) = \ell(\lambda) - \ell(\mu)$$

so  $\ell = \ell(\lambda) - 1 + k$  and  $m = \ell(\mu) - 1 + k$  for some  $k \in \mathbf{N}_0$ , as required. For the ‘finally part’, the hypotheses imply that  $H(\lambda) = H(\mu')$  so by Theorem 3.4(h), if there is a plethystic equivalence then  $C(\lambda) + d = C(\mu)$  for some  $d \in \mathbf{Z}$ . But this contradicts Lemma 5.3.  $\square$

We end this section by remarking that, by Proposition 3.6, a plethystic isomorphism  $\nabla^\lambda \text{Sym}^{\ell(\lambda)-1+k} E \cong \nabla^{\lambda'} \text{Sym}^{a(\lambda)-1+k} E$  given by Theorem 5.5 extends to the overgroup  $\text{MGL}_2^{(d)}(\mathbf{C})$  of  $\text{SL}_2(\mathbf{C})$  if and only if  $d$  divides  $|\lambda|(a(\lambda) - \ell(\lambda))/2$ . (Note this condition does not involve  $k$ .) In particular, there is a  $\text{GL}_2(\mathbf{C})$  isomorphism if and only if  $a(\lambda) = \ell(\lambda)$ . But in this case, since  $\mathcal{EP}(\lambda) = \mathcal{SP}(\lambda)'$ , we have  $E(\lambda) = S(\lambda)$ , and so  $\lambda = \lambda'$ . We conclude that there are infinitely many plethystic isomorphisms of  $\text{GL}_2(\mathbf{C})$ -representations  $\nabla^\lambda \text{Sym}^\ell E \cong \nabla^\mu \text{Sym}^m E$  if and only if  $\lambda = \mu$ .

## 6. MULTIPLE EQUIVALENCES

We need two lemmas on difference multisets.

**Lemma 6.1.** *Let  $X$  and  $Y$  be finite multisubsets of  $\mathbf{Z}$  and let  $a, b, c \in \mathbf{N}_0$ . If  $(X+a)/X = (Y+b)/(Y+c)$  then either  $a = 0$  and  $b = c$  or  $a \neq 0$ ,  $b > c$ ,  $\max X + a = \max Y + b$  and  $\min X = \min Y + c$ .*

*Proof.* Clearly  $a = 0$  if and only if  $b = c$ . Suppose neither is the case. Since  $a > 0$  the maximum element with non-zero multiplicity in the left-hand side is  $\max X + a$ . Since it has positive multiplicity,  $b > c$  and hence  $\max X + a = \max Y + b$ . Similarly the minimum element in the left-hand side with non-zero multiplicity is  $\min X$ , with negative multiplicity, and so  $\min X = \min Y + c$ .  $\square$

**Lemma 6.2.** *Let  $Z$  and  $W$  be finite multisubsets of  $\mathbf{Z}$  and let  $t \in \mathbf{Z}$  be non-zero. If  $Z/W = (Z+t)/(W+t)$  then  $Z = W$ .*

*Proof.* Suppose, for a contradiction, that  $Z \neq W$ . Let  $x$  to be greatest element with non-zero multiplicity in  $Z/W$ . Clearly  $x+t$  is the greatest element with non-zero multiplicity in  $(Z+t)/(W+t)$ . But  $Z/W = (Z+t)/(W+t)$  so  $x = x+t$ , hence  $t = 0$ , a contradiction.  $\square$

*Proof of Theorem 1.4(i) and (ii).* If  $\ell = \ell^\dagger$  then from  $\lambda \underset{\ell}{\sim} \mu$  and  $\lambda \underset{\ell^\dagger}{\sim} \mu$  we get  $\mu \underset{m}{\sim} \lambda$  and  $\lambda \underset{m^\dagger}{\sim} \mu$ , and so by Lemma 4.2,  $\mu \underset{m}{\sim} \mu$ . But now, by Lemma 4.5, we have  $m = m^\dagger$ , contradicting that the pairs  $(\ell, m)$  and  $(\ell^\dagger, m^\dagger)$  are distinct. Therefore we may suppose that  $\ell < \ell^\dagger$ , and in (ii) of the three plethystic equivalences, two are prime. It therefore suffices to prove (i).



For (i), since  $\ell \geq \ell(\lambda)$ , Proposition 4.7 implies that  $a(\lambda) + \ell = a(\mu) + m$  and  $a(\lambda) + \ell^\dagger = a(\mu) + m^\dagger$ . Let  $t = \ell^\dagger - \ell = m^\dagger - m \in \mathbf{N}$  denote the common difference. By Theorem 3.4(h), we have equalities of difference multisets

$$(6.1) \quad \begin{aligned} (C(\lambda) + \ell + 1)/H(\lambda) &= (C(\mu) + m + 1)/H(\mu) \\ (C(\lambda) + \ell + t + 1)/H(\lambda) &= (C(\mu) + m + t + 1)/H(\mu). \end{aligned}$$

Hence

$$(C(\lambda) + \ell + 1)/(C(\mu) + m + 1) = (C(\lambda) + \ell + t + 1)/(C(\mu) + m + t + 1).$$

By Lemma 6.2, we deduce that  $C(\lambda) + \ell + 1 = C(\mu) + m + 1$ . Writing  $Z$  for this multiset, (6.1) can be restated as  $Z/H(\lambda) = Z/H(\mu)$ , which implies that  $H(\lambda) = H(\mu)$ . Therefore either  $\lambda = \mu$ , or the hypotheses for Theorem 5.5(ii) hold, and we may conclude that  $\mu = \lambda'$  and  $\mathcal{SP}(\lambda) = \mathcal{EP}(\lambda)'$ .  $\square$

*Proof of Theorem 1.4(iii).* By Theorem 3.4(h) the hypotheses imply

$$\begin{aligned} (C(\lambda) + n + 1)/H(\lambda) &= (C(\mu) + n + 1)/H(\mu) \\ (C(\lambda) + n^\dagger + 1)/H(\lambda) &= (C(\mu) + n^\dagger + 1)/H(\mu). \end{aligned}$$

Hence

$$(C(\lambda) + n + 1) \cup (C(\mu) + n^\dagger + 1) = (C(\mu) + n + 1) \cup (C(\lambda) + n^\dagger + 1).$$

Subtracting  $n + 1$  from every element of these multisets we obtain

$$C(\lambda)/C(\mu) = (C(\lambda) + n^\dagger - n)/(C(\mu) + n^\dagger - n).$$

By Lemma 6.2 applied with  $Z = C(\lambda)$ ,  $W = C(\mu)$  and  $t = n^\dagger - n$  we have  $C(\lambda) = C(\mu)$ . Therefore  $\lambda = \mu$ , as required.  $\square$

## 7. COMPLEMENTARY PARTITIONS

Let  $\lambda$  be a partition such that  $\ell(\lambda) \leq r$ . Recall that  $\lambda^{or}$  denotes the complementary partition to  $\lambda$  in the  $r \times a(\lambda)$  box. Equivalently,  $\lambda_i^{or} = a(\lambda) - \lambda_{r+1-i}$  for each  $i \in \{1, \dots, r\}$ . In §2.3 we defined the set  $\text{SSYT}_{\leq \ell}(\lambda)$  of semistandard  $\lambda$ -tableaux with entries in  $\{0, 1, \dots, \ell\}$ . We extend this notation in the obvious way to define  $\text{SSYT}_{< r}(\lambda)$ . Given  $t \in \text{SSYT}_{< r}(\lambda)$ , let  $t^{or}$  be the unique column standard  $\lambda^{or}$ -tableau  $t^{or}$  having as its entries in column  $j$  the complement in  $\{0, 1, \dots, r-1\}$  of the entries of  $t$  in column  $a(\lambda) + 1 - j$ . For example if  $\lambda = (3, 2, 2, 1)$  then  $\lambda^{o5} = (3, 2, 1, 1)$  and under the map  $t \mapsto t^{o5}$  we have

$$\begin{array}{|c|c|c|} \hline 0 & 0 & 0 \\ \hline 1 & 1 & \\ \hline 2 & 2 & \\ \hline 3 & & \\ \hline \end{array} \mapsto \begin{array}{|c|c|c|} \hline 1 & 3 & 4 \\ \hline 2 & 4 & \\ \hline 3 & & \\ \hline 4 & & \\ \hline \end{array}.$$

The following proposition is implicit in [18, §4].

**Proposition 7.1.** *The map  $t \mapsto t^{\text{or}}$  is a self-inverse bijection*

$$\text{SSYT}_{<r}(\lambda) \rightarrow \text{SSYT}_{<r}(\lambda^{\text{or}}).$$

*Proof.* The only non-obvious claim is that  $t^{\text{or}}$  is semistandard. Suppose, for a contradiction, that columns  $a(\lambda) - j - 1$  and  $a(\lambda) - j$  of  $t^{\text{or}}$  have entries  $m_1^\circ \leq k_1^\circ, \dots, m_{i-1}^\circ \leq k_{i-1}^\circ$  and  $m_i^\circ > k_i^\circ$  when read from top to bottom. Let columns  $j$  and  $j + 1$  of  $t$  read from top to bottom have entries  $k_1 \leq m_1, \dots, k_h \leq m_h$  where  $h$  is greatest such that  $m_h < m_i^\circ$ . Then  $\{m_1^\circ, \dots, m_{i-1}^\circ, m_1, \dots, m_h\}$  are all the numbers strictly less than  $m_i^\circ$  in  $\{0, 1, \dots, r-1\}$ , since, by choice of  $h$ , if  $m_{h+1}$  is defined then  $m_{h+1} > m_i^\circ$ . But from the chain  $m_i^\circ > k_i^\circ > \dots > k_1^\circ$  and the inequalities  $m_i^\circ > m_h \geq m_j \geq k_j$  for  $j \in \{1, \dots, h\}$ , we see that  $m_i^\circ$  is strictly greater than  $i + h$  distinct numbers, a contradiction.  $\square$

*Proof of Theorem 1.5.* For the ‘if’ direction we give a slightly simplified version of the argument in [18]. By construction of  $t^{\text{or}}$  we have  $|t| + |t^{\text{or}}| = a(\lambda)r(r-1)/2$ . Therefore Proposition 7.1 implies that  $|\mathcal{S}_e^{r-1}(\lambda^{\text{or}})| = |\mathcal{S}_{ar(r-1)/2-e}^{r-1}(\lambda)|$  for each  $e \in \mathbf{N}_0$ . Recall from (3.1) that  $s_\lambda(1, q, \dots, q^\ell) = \sum_{e \in \mathbf{N}_0} |\mathcal{S}_e^\ell(\lambda)| q^e$ . Thus the coefficient of  $q^e$  in  $s_{\lambda^{\text{or}}}(1, q, \dots, q^{r-1})$  agrees with the coefficient of  $q^{a(\lambda)r(r-1)/2-e}$  in  $s_\lambda(1, q, \dots, q^{r-1})$ , and so

$$s_{\lambda^{\text{or}}}(1, q, \dots, q^{r-1}) = q^{a(\lambda)r(r-1)/2} s_\lambda(1, q^{-1}, \dots, q^{-(r-1)}).$$

By the central symmetry in the ‘moreover’ part of Theorem 3.4,

$$q^{-(r-1)|\lambda|/2} s_\lambda(1, q, \dots, q^{r-1}) = q^{(r-1)|\lambda|/2} s_\lambda(1, q^{-1}, \dots, q^{-(r-1)}).$$

Hence

$$s_{\lambda^{\text{or}}}(1, q, \dots, q^{r-1}) = q^{(r-1)(a(\lambda)r/2-|\lambda|)} s_\lambda(1, q, \dots, q^{r-1}).$$

By Theorem 3.4(e), we have  $\lambda^{\text{or}} \underset{r-1}{\sim} \underset{r-1}{\sim} \lambda$ , as required.

For the ‘only if’ direction suppose that  $\lambda \neq \lambda^{\text{or}}$  and  $\lambda \underset{\ell}{\sim} \lambda^{\text{or}}$ . From the ‘if’ direction, we have  $\lambda \underset{r-1}{\sim} \lambda^{\text{or}}$ . By Theorem 1.4(ii) we deduce that  $\ell = r - 1$ , as required.  $\square$

## 8. RECTANGULAR EQUIVALENCES AND $q$ -BINOMIAL IDENTITIES

In this section we determine all plethystic equivalences  $\lambda \underset{\ell}{\sim} \mu$  in which one or both of  $\lambda$  and  $\mu$  is a *rectangle*, of the form  $(a^b)$  with  $a, b \in \mathbf{N}$ . Our main result is as follows.

**Theorem 8.1.** *Let  $\lambda$  be a partition and let  $a, b, c \in \mathbf{N}$ . Then  $\lambda \underset{\ell}{\sim} (a^b)$  if and only if  $\lambda$  is obtained by adding columns of length  $\ell + 1$  to a rectangle  $(a^{b'})$  with  $b' \leq \ell$  and  $(a', b', \ell - b' + 1)$  is a permutation of  $(a, b, c)$ .*

Clearly this implies Theorem 1.6. Conversely, as seen in Example 1.12, by using Lemma 4.1 and Lemma 4.2 one may reduce to the case when  $\ell \geq \ell(\lambda)$  of a prime plethystic equivalence. Therefore Theorem 8.1 follows routinely from Theorem 1.6.

In the following subsection we use Theorem 3.4(e) to show that the ‘if’ direction of Theorem 1.6 is the representation-theoretic realization of the six-fold symmetry group of plane partitions. Next we prove a new determinantal formula using  $q$ -binomial coefficients of MacMahon’s generating function of plane partitions. We then prove the ‘only if’ direction of Theorem 1.6 using certain unimodal graphs to keep track of the contents of rectangles. The section ends with the corollary for the case  $b = 1$ ; this generalizes the Hermite reciprocity seen in §1.2.

**8.1. Plane partitions.** Recall that a *plane partition* of shape  $\lambda$  is a  $\lambda$ -tableau with entries from  $\mathbf{N}$  whose rows and columns are weakly decreasing, when read left to right and top to bottom. Let  $\mathcal{PP}(a, b, c)$  denote the set of plane partitions  $\pi$  with entries in  $\{1, \dots, c\}$  whose shape  $\text{sh}(\pi)$  is contained in  $[(a^b)]$ . Assigning 0 to each box of  $[(a^b)] \setminus \text{sh}(\pi)$  defines a bijection between  $\mathcal{PP}(a, b, c)$  and the set of  $(a^b)$ -tableaux with entries from  $\mathbf{N}_0$  and weakly decreasing rows and columns. Observe that if  $t$  is such a tableau then rotating  $t$  by a half-turn and adding  $j - 1$  to every entry in row  $j$  gives a semistandard tableau of shape  $(a^b)$  with entries in  $\{0, 1, \dots, b + c - 1\}$ . Again this map is bijective. Hence we have

$$(8.1) \quad q^{-a \binom{b}{2}} s_{(a^b)}(1, q, \dots, q^{b+c-1}) = \sum_{\pi \in \mathcal{PP}(a, b, c)} q^{|\pi|}$$

where, extending our usual notation,  $|\pi|$  denote the sum of entries of a plane partition  $\pi$ .

*Proof of ‘if’ direction of Theorem 1.6.* Representing elements of  $\mathcal{PP}(a, b, c)$  plane partitions by three-dimensional Young diagrams contained in the  $a \times b \times c$  cuboid, it is clear that the right-hand side of (8.1) is invariant under permutation of  $a, b, c$ . The ‘if’ direction now follows from Theorem 3.4(e).  $\square$

**8.2. MacMahon’s identity.** In [21, page 659], MacMahon proved that

$$(8.2) \quad \sum_{\pi \in \mathcal{PP}(a, b, c)} q^{|\pi|} = \prod_{i=1}^a \prod_{j=1}^b \prod_{k=1}^c \frac{q^{i+j+k-1} - 1}{q^{i+j+k-2} - 1}.$$

This makes the invariance of (8.1) under permutation of  $a, b$  and  $c$  algebraically obvious. For a modern proof using (8.1) and Stanley’s Hook Content Formula see (7.109) and (7.111) in [29]. In this section we prove Corollary 8.4, which gives a new  $q$ -binomial form for the right-hand side of MacMahon’s formula. Specializing  $q$  to 1 in this corollary we obtain the

attractive identity

$$\prod_{i=1}^a \prod_{j=1}^b \prod_{k=1}^c \frac{i+j+k-1}{i+j+k-2} = \det \begin{pmatrix} b+c+i+j & & \\ & b+j & \\ & & \end{pmatrix}_{0 \leq i, j \leq a-1}.$$

Proving the invariance of the right-hand side under permutation of  $a$ ,  $b$  and  $c$  was asked as a MathOverflow question by T. Amdeberhan<sup>1</sup> in 2019.

*Hermite reciprocity and  $q$ -binomial coefficients.* Recall from (2.11) that  $[m]_q = (q^m - 1)/(q - 1) \in \mathbf{C}[q]$  for  $m \in \mathbf{N}_0$ . Set  $[m]_q = 0$  if  $m < 0$ . For  $m, \ell \in \mathbf{N}_0$ , we define the  $q$ -binomial coefficient  $\begin{bmatrix} m \\ \ell \end{bmatrix} \in \mathbf{C}[q]$  by

$$\begin{bmatrix} m \\ \ell \end{bmatrix} = \frac{[m]_q \dots [m - \ell + 1]_q}{[\ell]_q \dots [1]_q}.$$

As motivation, we note that, by Stanley's Hook Content Formula (Theorem 2.12), we have  $s_{(n)}(1, q, \dots, q^\ell) = \begin{bmatrix} n+\ell \\ \ell \end{bmatrix}$ . We saw in the first proof of Hermite reciprocity in §1.2 that  $s_{(n)}(1, q, \dots, q^\ell)$  is the generating function for partitions contained in the  $n \times \ell$  box. Thus the well-known invariance of  $\begin{bmatrix} n+\ell \\ \ell \end{bmatrix}$  under swapping  $n$  and  $\ell$  is equivalent to Hermite reciprocity.

*Jacobi–Trudi.* Let  $e_m$  be the elementary symmetric function of degree  $m$ . By [29, Proposition 7.8.3] we have  $e_\ell(1, q, \dots, q^{m-1}) = q^{\binom{\ell}{2}} \begin{bmatrix} m \\ \ell \end{bmatrix}$ . It will be convenient to denote the right-hand side by  $|\begin{bmatrix} m \\ \ell \end{bmatrix}|$ . Using this notation, the dual Jacobi–Trudi formula (see [29, Corollary 7.16.2]) implies that

$$(8.3) \quad s_{(ab)}(1, q, \dots, q^{b+c-1}) = \det \left( \begin{vmatrix} b+c & & \\ & b+j & \\ & & b+j-i \end{vmatrix}_{0 \leq i, j \leq a-1} \right).$$

*A determinantal form of MacMahon's identity.* We now apply row and column operations to the matrix in (8.3) using the following two versions of the Chu–Vandermonde identity for our scaled  $q$ -binomial coefficients. To make the article self-contained we include bijective proofs using that  $|\begin{bmatrix} m \\ \ell \end{bmatrix}|$  is the generating function enumerating  $\ell$ -subsets of  $\{0, \dots, m-1\}$  by their sum of entries. (This easily follows from [30, Proposition 1.7.3].) A different proof of (8.4) using the  $q$ -binomial theorem is given in the solution to Exercise 100 in [30].

**Lemma 8.2.** *We have*

$$(8.4) \quad \begin{vmatrix} m+r \\ \ell+r \end{vmatrix} = \sum_k q^{mk} \begin{vmatrix} r \\ k \end{vmatrix} \begin{vmatrix} m \\ \ell+r-k \end{vmatrix},$$

$$(8.5) \quad \begin{vmatrix} m+r \\ \ell+r \end{vmatrix} = \sum_k q^{r(\ell+r-k)} \begin{vmatrix} r \\ k \end{vmatrix} \begin{vmatrix} m \\ \ell+r-k \end{vmatrix}.$$

<sup>1</sup>See [mathoverflow.net/q/322894/7709](https://mathoverflow.net/q/322894/7709).

*Proof.* For (8.4), observe that a  $(\ell + r)$ -subset of  $\{0, 1, \dots, m + r - 1\}$  containing exactly  $k$  elements of  $\{m, \dots, m + r - 1\}$  has a unique decomposition as  $Y \cup Z$  where  $Y$  is a  $k$ -subset of  $\{m, \dots, m + r - 1\}$  and  $Z$  is an  $(\ell + r - k)$ -subset of  $\{0, 1, \dots, m - 1\}$ . These pairs are enumerated, according to their sum of entries, by  $q^{mk} \binom{r}{k}$  and  $\binom{m}{\ell + r - k}$ , respectively. Identity (8.5) can be proved similarly by splitting the subset as  $Y' \cup Z'$  where  $Y'$  is a  $k$ -subset of  $\{0, \dots, r - 1\}$  and  $Z'$  is an  $(\ell + r - k)$ -subset of  $\{r, \dots, m + r - 1\}$ .  $\square$

**Proposition 8.3.** *For any  $a, b, c \in \mathbf{N}$  we have*

$$\begin{aligned} q^{a \binom{b}{2}} \prod_{i=1}^a \prod_{j=1}^b \prod_{k=1}^c \frac{q^{i+j+k-1} - 1}{q^{i+j+k-2} - 1} &= \det \left( \begin{array}{c} b + c + j \\ b + j - i \end{array} \right) \\ &= q^{-A} \det \left( q^{-ij} \begin{array}{c} b + c + i + j \\ b + j \end{array} \right) \end{aligned}$$

where each determinant is of an  $a \times a$  matrix with entries defined by taking  $0 \leq i, j \leq a - 1$ , and  $A = \binom{a}{2}b - \binom{a+1}{3}$ .

*Proof.* Let  $M$  be the matrix with entries  $\binom{b+c}{b+j-i}$  for  $0 \leq i, j \leq a - 1$  appearing in (8.3). Let  $C_j$  denote the  $j$ th column of  $M$ , where columns are numbered from 0 up to  $a - 1$ . Let  $M'$  be the matrix obtained from  $M$  by replacing  $C_j$  with the linear combination

$$\sum_{j'=0}^j q^{(b+c)(j-j')} \begin{array}{c} j \\ j - j' \end{array} \Big| C_{j'}$$

for each  $j \in \{0, \dots, a - 1\}$ . Since  $\binom{j}{0} = 1$ , we have  $\det M' = \det M$ . By (8.4), taking  $m = b + c$ ,  $\ell = b - i$  and  $r = j$  and replacing the summation variable  $k$  with  $j - j'$ , we have

$$\begin{array}{c} b + c + j \\ b + j - i \end{array} \Big| = \sum_{j'} q^{(b+c)(j-j')} \begin{array}{c} j \\ j - j' \end{array} \Big| \begin{array}{c} b + c \\ b + j' - i \end{array} \Big|.$$

Therefore  $M'$  has entries  $\binom{b+c+j}{b+j-i}$  as required for the first equality. Let  $R'_i$  denote the  $i$ th row of  $M'$ . Let  $M''$  be the matrix obtained from  $M'$  by replacing  $R'_i$  with the linear combination

$$\sum_{i'=0}^i q^{i(b-i')} \begin{array}{c} i \\ i' \end{array} \Big| R'_{i'}$$

for each  $i \in \{0, \dots, a - 1\}$ . Since  $q^{i(b-i)} \binom{i}{i} = q^{i(b-i) + \binom{i}{2}}$  and

$$\sum_{i=0}^{a-1} \left( i(b-i) + \binom{i}{2} \right) = \sum_{i=0}^{a-1} ib - \sum_{i=0}^{a-1} \binom{i+1}{2} = b \binom{a}{2} - \binom{a+1}{3}$$

we have  $\det M'' = q^{\binom{a}{2}b - \binom{a+1}{3}} \det M'$ . By (8.5) taking  $m = b + c + j$ ,  $\ell = b + j - i$  and  $r = i$  and replacing the summation variable  $k$  with  $i'$  we have

$$\begin{vmatrix} b + c + i + j \\ b + j \end{vmatrix} = \sum_{j'} q^{i(b+j-i')} \begin{vmatrix} i \\ i' \end{vmatrix} \begin{vmatrix} b + c + j \\ b + j - i' \end{vmatrix}.$$

Multiplying through by  $q^{-ij}$ , we see that  $M''$  has entries  $q^{-ij} \begin{vmatrix} b+c+i+j \\ b+j \end{vmatrix}$ . The final equality follows.  $\square$

We note that the  $q \rightarrow 1$  limit of the first formula in Proposition 8.3 is equivalent, by standard bijections between plane partitions and rhombal tilings, to (2.4) in [9].

**Corollary 8.4.** *For any  $a, b, c \in \mathbf{N}$  we have*

$$\prod_{i=1}^a \prod_{j=1}^b \prod_{k=1}^c \frac{q^{i+j+k-1} - 1}{q^{i+j+k-2} - 1} = q^{1^2 + \dots + (a-1)^2} \det \left( q^{-ij} \begin{vmatrix} b + c + i + j \\ b + j \end{vmatrix} \right)_{0 \leq i, j < a}.$$

*Proof.* Let  $N$  be the  $a \times a$  matrix on the right-hand side. Since  $\begin{vmatrix} b+c+i+j \\ b+j \end{vmatrix} = q^{\binom{b+j}{2}} \begin{bmatrix} b+c+i+j \\ b+j \end{bmatrix}$  and  $\sum_{j=0}^{a-1} \binom{b+j}{2} = \binom{a+b}{3} - \binom{b}{3}$ , it follows from the second equality in Proposition 8.3 that

$$q^{a \binom{b}{2}} \prod_{i=1}^a \prod_{j=1}^b \prod_{k=1}^c \frac{q^{i+j+k-1} - 1}{q^{i+j+k-2} - 1} = q^{-\binom{a}{2}b + \binom{a+1}{3} + \binom{a+b}{3} - \binom{b}{3}} \det N.$$

By direct calculation one finds that

$$-a \binom{b}{2} - \binom{a}{2}b + \binom{a+1}{3} + \binom{a+b}{3} - \binom{b}{3} = \frac{a(a-1)(2a-1)}{6}.$$

The identity now follows using  $1^2 + \dots + (a-1)^2 = a(a - \frac{1}{2})(a-1)/3$ .  $\square$

**8.3. Plethystic equivalences between rectangles.** In this subsection we prove the ‘only if’ direction of Theorem 1.6. The following lemma gives one useful reduction.

**Lemma 8.5.** *Let  $a, b \in \mathbf{N}$  and let  $\mu$  be a partition. If  $d \geq b$  and  $m \geq \ell(\mu) - 1$  then  $(a^b)_{d-1} \sim_m \mu$  if and only if  $(a^{d-b})_{d-1} \sim_m \mu$ .*

*Proof.* Since  $(a^{d-b})$  is the complement of  $(a^b)$  in the  $d \times a$  box, we have  $(a^b)_{d-1} \sim_{d-1} (a^{d-b})$  by Theorem 1.5. Now apply Lemma 4.2.  $\square$

As seen here, it is most convenient to work with the shift applied to the content multiset: thus  $d = \ell + 1$  in the usual notation. Recall from Definition 2.11 that  $h_{(i,j)}(\lambda)$  denotes the hook length of the box  $(i, j) \in [\lambda]$ .

**Definition 8.6.** Let  $\lambda$  be a non-empty partition and let  $d \geq \ell(\lambda)$ . Define  $c_\lambda^{(d)} : \mathbf{N}_0 \rightarrow \mathbf{N}_0$  and  $h_\lambda : \mathbf{N}_0 \rightarrow \mathbf{N}_0$  by

$$\begin{aligned} c_\lambda^{(d)}(k) &= |\{(i, j) \in [\lambda] : j - i + d = k\}| \\ h_\lambda(k) &= |\{(i, j) \in [\lambda] : h_{(i,j)} = k\}| \end{aligned}$$

and the *content-hook function*  $\text{ch}_\lambda^{(d)} : \mathbf{N}_0 \rightarrow \mathbf{Z}$  by  $\text{ch}_\lambda^{(d)} = c_\lambda^{(d)} - h_\lambda$ .

By Theorem 3.4(h), we have

$$(8.6) \quad (a^b)_{d-1} \sim_{d'-1} (a^{b'}) \iff \text{ch}_{(a^b)}^{(d-1)} = \text{ch}_{(a^{b'})}^{(d'-1)}.$$

The equalities on the right-hand side of (8.6) can easily be classified from the graphs of the content-hook functions. We include full details to save the reader case-by-case checking. As a visual guide, in inequalities and graphs we write  $x$ -coordinates relevant to the content in bold.

**Lemma 8.7.** *Let  $b \leq d$ . If  $b \leq a$  then the graphs of  $c_{(a^b)}^{(d)}$  and  $-h_{(a^b)}$  are*

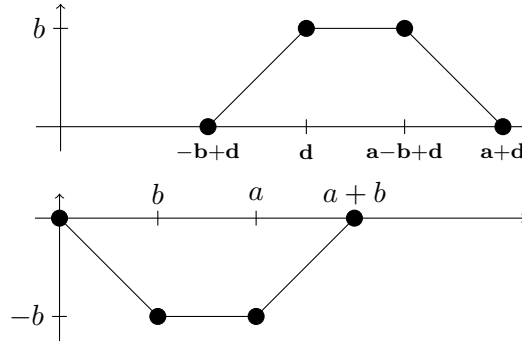

*If  $b \geq a$  then the graphs of  $c_{(a^b)}^{(d)}$  and  $h_{(a^b)}$  are*

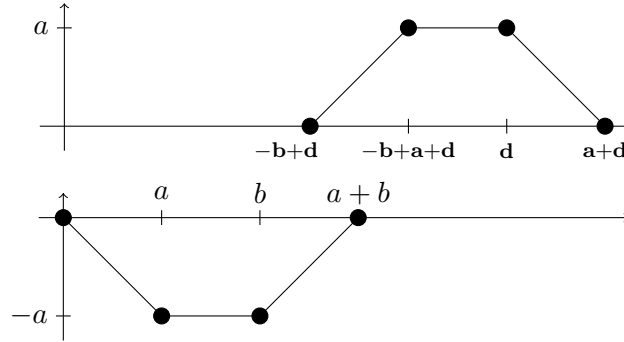

*Proof.* Suppose that  $b \leq a$ . The unique least and greatest elements of  $C((a^b)) + d$  are  $-b + 1 + d$  and  $a - 1 + d$ , respectively. Moreover  $d$  and  $a - b + d$  are the least and greatest element of the maximum multiplicity  $b$ . Thus  $(-b + d, 0)$ ,  $(b, d)$ ,  $(a - b + d, 0)$  and  $(a + d, 0)$  are points on the graph of  $c_{(a^b)}^{(d)}$ . It is easily seen that, between each adjacent pair of points, the graph is linear. The graph of  $h_{(a^b)}$  can be found similarly.  $\square$

By Lemma 8.5, we may reduce to the case where  $2b \leq d$ , which we now consider.

**Lemma 8.8.** *Let  $2b \leq d$ . If  $b \leq a$  then precisely one of:*

- (i)  $b \leq -b + d \leq d \leq a < a + b \leq a - b + d < a + d$ ;
- (ii)  $b \leq -b + d \leq a < d \leq a + b \leq a - b + d < a + d$ ;

$$(iii) \quad b \leq a < -\mathbf{b} + \mathbf{d} < a + b < \mathbf{d} \leq \mathbf{a} - \mathbf{b} + \mathbf{d} < \mathbf{a} + \mathbf{d};$$

$$(iv) \quad b \leq a < a + b \leq -\mathbf{b} + \mathbf{d} < \mathbf{d} \leq \mathbf{a} - \mathbf{b} + \mathbf{d} < \mathbf{a} + \mathbf{d}.$$

If  $a < b$  then precisely one of

$$(v) \quad a < b \leq -\mathbf{b} + \mathbf{d} \leq a + b \leq \mathbf{a} - \mathbf{b} + \mathbf{d} < \mathbf{d} < \mathbf{a} + \mathbf{d};$$

$$(vi) \quad a < b < a + b < -\mathbf{b} + \mathbf{d} \leq \mathbf{a} - \mathbf{b} + \mathbf{d} \leq \mathbf{d} < \mathbf{a} + \mathbf{d}.$$

*Proof.* We have  $-\mathbf{b} + \mathbf{d} < \mathbf{d} < \mathbf{a} - \mathbf{b} + \mathbf{d} < \mathbf{a} + \mathbf{d}$  and  $b \leq a \leq a + b$ . We must consider how these chains interleave. By our reduction  $b \leq -\mathbf{b} + \mathbf{d}$ .

Suppose that  $b \leq a$ . By the reduction,  $a + b \leq \mathbf{a} - \mathbf{b} + \mathbf{d}$ , and so the interleaved chain ends  $\mathbf{a} - \mathbf{b} + \mathbf{d} < \mathbf{a} + b$ . If  $\mathbf{d} \leq a + b$  then either  $\mathbf{d} \leq a$ , giving (i), or  $a < \mathbf{d} \leq a + b$ , giving (ii). Otherwise  $a + b < \mathbf{d}$  and so  $a < -\mathbf{b} + \mathbf{d}$ . Either  $-\mathbf{b} + \mathbf{d} < a + b$  giving (iii) or  $a + b \leq -\mathbf{b} + \mathbf{d}$  giving (iv).

Suppose that  $a < b$ . By the reduction,  $a + b \leq \mathbf{a} - \mathbf{b} + \mathbf{d} < \mathbf{d} < \mathbf{a} + \mathbf{d}$ , so the interleaved chain ends  $\mathbf{a} - \mathbf{b} + \mathbf{d} < \mathbf{d} < \mathbf{a} + \mathbf{d}$ . If  $-\mathbf{b} + \mathbf{d} \leq a + b$  we have (v), otherwise (vi).  $\square$

**Lemma 8.9.** *The graphs of  $\text{ch}_{(a^b)}^{(d)}$  in each of the cases in Lemma 8.8 are as shown in Figure 4 overleaf.*

*Proof.* This is routine from Lemma 8.7 and Lemma 8.8.  $\square$

We are now ready to prove the ‘only if’ direction of Theorem 1.6.

*Proof.* By hypothesis  $\ell \geq \ell(\lambda)$  and  $(a^b)_{b+c-1} \sim_{\ell} \lambda$ . Let  $d = b + c$ . It follows from Lemma 4.4 that  $\lambda$  is a rectangle. Let  $\lambda = (a^{b'})$  and let  $\ell = b' + c' - 1$  where  $c' \in \mathbf{N}$ . Set  $d' = b' + c'$ . Since the six-fold equivalences given by the ‘if’ direction of Theorem 1.6 form a group, we may use Lemma 8.5 to assume that  $2b \leq d$  and  $2b' \leq d'$ . Using (8.6), it suffices to show that  $\text{ch}_{(a^b)}^{(d)} = \text{ch}_{(a^{b'})}^{(d')}$  only if  $(a', b', c')$  is a permutation of  $(a, b, c)$ .

Say that a graph in Lemma 8.9 is *generic* if it has a piecewise-linear part of gradient 0 or 2 in its middle. For example, the graph in (i) is generic if and only if  $\mathbf{d} < a$ . For each generic graph there are two other generic graphs with which it may agree, giving six cases we must check. These are surprisingly simple to resolve. To give a typical instance, suppose that the hook-content functions in case (i) for  $(a^b)$  and shift  $d$  and case (iv) for  $(a^{b'})$  and shift  $d'$  agree. Comparing the inequality chains from Lemma 8.8, namely

$$b \leq -\mathbf{b} + \mathbf{d} \leq \mathbf{d} \leq a < a + b \leq \mathbf{a} - \mathbf{b} + \mathbf{d} < \mathbf{a} + \mathbf{d}$$

$$b' \leq a' < a' + b' \leq -\mathbf{b}' + \mathbf{d}' \leq \mathbf{d}' \leq \mathbf{a}' - \mathbf{b}' + \mathbf{d}' < \mathbf{a}' + \mathbf{d}'$$

shows that  $b' = b$ ,  $a' = -b + d = c$  and  $d' = a + b$ . Hence  $c' = d' - b' = a$  and  $(a', b', c') = (c, b, a)$ . The corresponding equivalence is  $(a^b)_{b+c-1} \sim_{a+b-1} (c^b)$ . The remaining generic cases are similar. The equations satisfied by  $a', b', d'$ , the permutation of  $(a, b, c)$  and the corresponding equivalence are shown in the table below; the first line is the case already considered.



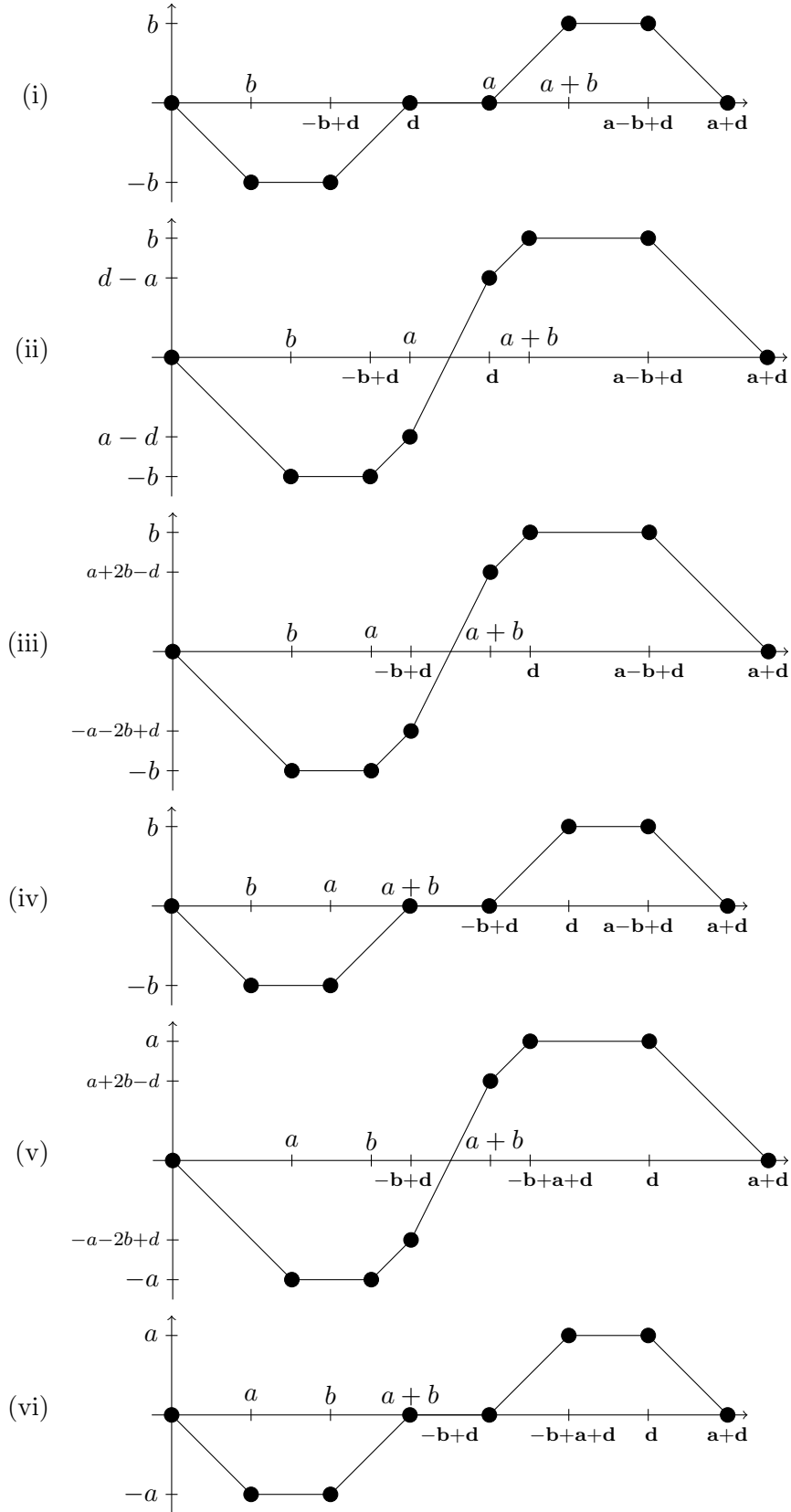

FIGURE 4. Graphs of  $\text{ch}_{(a^b)}^{(d)}$  in each of the cases in Lemma 8.8.

(i), (iv)	$a'=-b+d$	$b'=b$	$d'=a+b$	$(c, b, a)$	$(a^b)_{b+c-1} \sim_{a+b-1} (c^b)$
(i), (vi)	$a'=b$	$b'=-b+d$	$d'=a-b+d$	$(b, c, a)$	$(a^b)_{b+c-1} \sim_{a+c-1} (b^c)$
(iv), (vi)	$a'=b$	$b'=a$	$d'=a-b+d$	$(b, a, c)$	$(a^b)_{b+c-1} \sim_{a+c-1} (b^a)$
(ii), (iii)	$a'=-b+d$	$b'=b$	$d'=a+b$	$(c, b, a)$	$(a^b)_{b+c-1} \sim_{a+b-1} (c^b)$
(ii), (v)	$a'=b$	$b'=-b+d$	$d'=a-b+d$	$(b, c, a)$	$(a^b)_{b+c-1} \sim_{a+c-1} (b^c)$
(iii), (v)	$a'=b$	$b'=a$	$d'=a-b+d$	$(b, a, c)$	$(a^b)_{b+c-1} \sim_{a+c-1} (b^a)$

In the non-generic cases (i) and (ii) agree when  $a = d$ ; (iii) and (iv) agree when  $-b + d = a + b$ ; (v) and (vi) agree when  $-b + d = a + b$ . Therefore we need only compare cases (i), (iii) and (v) using Lemma 8.9. If (i) and (iii) agree then  $d = a = -b + d = a + b$ , hence  $b = 0$ , a contradiction. If (i) and (v) agree then  $d = a = -b + d = a + b$ , hence  $b = 0$ , again a contradiction. It is impossible for (iii) and (iv) to agree because  $b \leq a$  in (iii) and  $a < b$  in (v).  $\square$

**8.4. One-row partitions.** The special case of Theorem 8.1 for plethystic equivalences with a one-row partition is a natural generalization of Hermite reciprocity. It was stated as Corollary 1.7 in the introduction.

*Proof of Corollary 1.7.* By definition, there is an isomorphism  $\nabla^\lambda \text{Sym}^\ell E \cong \text{Sym}^a \text{Sym}^c E$  of  $\text{SL}_2(\mathbf{C})$ -representations if and only if  $\lambda \ell \sim_c (a)$ . By Theorem 8.1, this holds if and only if  $\lambda$  is obtained by adding columns of length  $\ell + 1$  to a rectangle  $(a^{b'})$  and  $(a', b', c')$  is a permutation of  $(a, b, c)$ . After the usual reduction using Lemma 4.1 and Lemma 4.2, we may assume the plethystic equivalence is  $(a^{b'}) \ell \sim_c (a)$ . Thus by Theorem 8.1,  $(a', b', \ell - b' + 1)$  is a permutation of  $(a, 1, c)$ . Considering rectangles in conjugate pairs, we see that  $(a^{b'})$  is one of  $(a)$ ,  $(1^a)$ ,  $(c)$ ,  $(1^c)$ ,  $(a^c)$ ,  $(c^a)$  and the equivalence is respectively  $(a) \sim_c (a)$ ,  $(1^a)_{a+c-1} \sim_c (a)$ ,  $(c) \sim_c (a)$ ,  $(1^c)_{a+c-1} \sim_c (a)$ ,  $(a^c) \sim_c (a)$ ,  $(c^a) \sim_c (a)$ , as required.  $\square$

## 9. IRREDUCIBLE SKEW-SCHUR FUNCTIONS

In this section we work in the more general setting of skew Schur functions. Recall that  $\lambda/\lambda^*$  is a *skew partition* if  $\lambda$  and  $\lambda^*$  are partitions with  $[\lambda^*] \subseteq [\lambda]$ . Let  $\text{SSYT}_{\leq \ell}(\lambda/\lambda^*)$  be the set of semistandard tableaux of shape  $\lambda/\lambda^*$  with entries in  $\{0, 1, \dots, \ell\}$ , defined as in §2.3 but replacing  $[\lambda]$  with  $[\lambda]/[\lambda^*]$ . The *weight* of a skew tableau  $t$ , denoted  $|t|$  is, as expected, its sum of entries. Extending Definition 2.8 in the obvious way, the *skew Schur function*  $s_{\lambda/\lambda^*}$  is the symmetric function defined by

$$(9.1) \quad s_{\lambda/\lambda^*}(x_0, x_1, \dots, x_n) = \sum_{t \in \text{SSYT}_{\leq \ell}(\lambda/\lambda^*)} x^{|t|}.$$

Similarly, let  $\mathcal{S}_e^\ell(\lambda/\lambda^*)$  be the subset of  $\text{SSYT}_{\leq \ell}(\lambda/\lambda^*)$  consisting of tableaux of weight  $e$ . Then

$$(9.2) \quad s_{\lambda/\lambda^*}(1, q, \dots, q^\ell) = \sum_{e \in \mathbf{N}_0} |\mathcal{S}_e^\ell(\lambda/\lambda^*)| q^e.$$

**Definition 9.1.** Let  $\ell \in \mathbf{N}_0$  and let  $\lambda/\lambda^*$  be a skew-partition. We say that  $s_{\lambda/\lambda^*}$  is  $\ell$ -irreducible if there exists  $b \in \mathbf{N}_0$  and  $m \in \mathbf{N}_0$  such that  $s_{\lambda/\lambda^*}(1, q, \dots, q^\ell) = q^b(1 + q + \dots + q^m)$ .

In (9.3) we show that  $b$  and  $m$  are determined in a simple way by  $\lambda/\lambda^*$  and  $\ell$ . This result and Lemma 9.7 can also be proved using the following remark; it is not logically essential, but should help to motivate Definition 9.1.

**Remark 9.2.** The GL-polytabloids  $F(t)$  defined in §2.4 for tableaux  $t$  of partition shape with entries from  $\{0, 1, \dots, \ell\}$  generalize in the obvious way to skew partitions. Using them we may define  $\nabla^{\lambda/\lambda^*} V$ , where as before  $V = \langle v_0, \dots, v_\ell \rangle$  is an  $(\ell + 1)$ -dimensional complex vector space, to be the submodule of  $\bigotimes_{i=1}^{\ell(\lambda)} \text{Sym}^{\lambda_i - \lambda_i^*} E$  spanned by the  $F(t)$  for  $t$  a  $\lambda/\lambda^*$ -tableau with entries from  $\{0, 1, \dots, \ell\}$ . This defines skew Schur functors  $\nabla^{\lambda/\lambda^*}$  in a way that does not depend on Littlewood–Richardson coefficients, or the complete reducibility of representations of  $\text{SL}_2(\mathbf{C})$ . Generalizing Lemma 2.7, we have

$$\Phi_{\nabla^{\lambda/\lambda^*} \text{Sym}^\ell E}(1, q) = s_{\lambda/\lambda^*}(1, q, \dots, q^\ell).$$

By a generalization of the equivalence of (a) and (e) in Theorem 3.4,  $s_{\lambda/\lambda^*}$  is  $\ell$ -irreducible in the sense of Definition 9.1 if and only if the polynomial representation  $\nabla^{\lambda/\lambda^*} \text{Sym}^\ell E$  of  $\text{SL}_2(\mathbf{C})$  is irreducible.

Note that  $\ell = 0$  is permitted in Definition 9.1 and in the previous remark. Since  $s_{\lambda/\lambda^*}(1, q, \dots, q^\ell)$  is non-zero if and only if every column of  $[\lambda/\lambda^*]$  has length at most  $\ell + 1$ , the 0-irreducible skew-partitions are precisely those with at most one box in each column.

**9.1. Irreducible skew Schur functions.** In this section we state a classification of all skew partitions  $\lambda/\lambda^*$  and  $\ell \in \mathbf{N}$  such that  $s_{\lambda/\lambda^*}$  is  $\ell$ -irreducible. We then deduce Corollary 1.8. The following definition leads to a useful reduction.

**Definition 9.3.** We say that a skew partition  $\lambda/\lambda^*$  is *proper* if  $\lambda_1 > \lambda_1^*$  and  $\lambda'_1 > \lambda_1'^*$ .

Given a non-empty skew partition  $\pi/\pi^*$  one may repeatedly remove the longest rows and columns from each of  $\pi$  and  $\pi^*$  to obtain the Young diagram of a unique proper skew partition  $\lambda/\lambda^*$  such that  $[\lambda/\lambda^*] = [\pi/\pi^*]$ , as illustrated in Figure 5. There is an obvious bijection between  $\text{SSYT}_{\{0, \dots, \ell\}}(\pi/\pi^*)$  and  $\text{SSYT}_{\{0, \dots, \ell\}}(\lambda/\lambda^*)$ . Therefore, by (9.1), we have  $s_{\pi/\pi^*}(1, q, \dots, q^\ell) =$

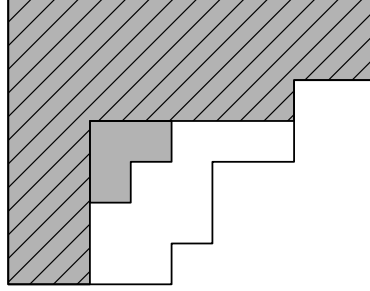

FIGURE 5. The Young diagram of a skew partition  $\pi/\pi^*$  with  $\pi^*$  shaded in grey is shown. Deleting the hatched boxes leaves the Young diagram of the proper skew partition  $\lambda/\lambda^*$ , where  $[\lambda^*]$  consists of the shaded unhatched boxes.

$s_{\lambda/\lambda^*}(1, q, \dots, q^\ell)$ . Thus there is no loss of generality in restricting to proper skew partitions. Our classification in this case uses the following definition.

**Definition 9.4.** Given a proper skew partition  $\lambda/\lambda^*$  with  $a(\lambda) = p$ , we define the *column lengths*  $c(\lambda/\lambda^*) \in \mathbf{N}^p$  by  $c(\lambda/\lambda^*)_j = \lambda'_j - \lambda^{*\prime}_j$  for  $1 \leq j \leq p$ . We say that  $\lambda/\lambda^*$  is

- (a) a *skew  $\ell$ -rectangle* where  $\ell \in \mathbf{N}_0$  if  $c(\lambda/\lambda^*)_1 = \dots = c(\lambda/\lambda^*)_p = \ell + 1$ ;
- (b) a *skew 1-near rectangle* of *width*  $d \in \mathbf{N}_0$  if there exist  $y$  such that

$$c(\lambda/\lambda^*)_y = \dots = c(\lambda/\lambda^*)_{y+d-1} = 1,$$

$$\lambda'_y = \dots = \lambda'_{y+d-1},$$

and  $c(\lambda/\lambda^*)_j = 2$  if  $1 \leq j < y$  or  $y + d \leq j \leq p$ ;

- (c) a *skew  $\ell$ -near rectangle* where  $\ell \geq 2$  if there exists  $z$  such that  $c(\lambda/\lambda^*)_z \in \{1, \ell\}$  and  $c(\lambda/\lambda^*)_j = \ell + 1$  if  $1 \leq j \leq p$  and  $j \neq z$ .

The Young diagrams of a skew 0-rectangle, a skew 1-near rectangle of width 3 and a skew 2-near rectangle are shown below; the final diagram fails the second displayed condition in (b), so is not a skew 1-near rectangle.

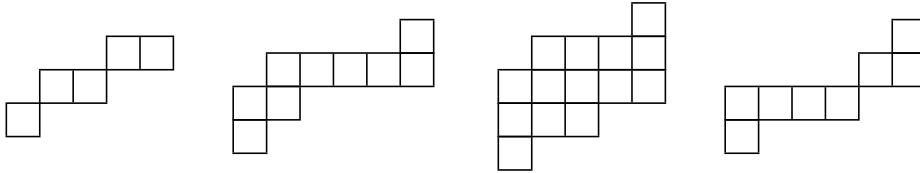

We can now state the classification.

**Theorem 9.5.** *Let  $\lambda/\lambda^*$  be a proper skew partition. Then  $s_{\lambda/\lambda^*}$  is  $\ell$ -irreducible if and only if  $\lambda/\lambda^*$  is a skew  $\ell$ -rectangle or  $\lambda/\lambda^*$  is a skew  $\ell$ -near rectangle.*

We immediately deduce the corollary for Schur functors labelled by partitions stated in the introduction.

*Proof of Corollary 1.8.* By Lemma 2.7,  $\nabla^\lambda \text{Sym}^\ell E \cong \text{Sym}^m E$  for some  $m \in \mathbf{N}_0$  if and only if  $s_\lambda$  is  $\ell$ -irreducible. The only skew 0-rectangles are one-part partitions. If, as in (b) in Definition 9.4,  $\ell = 1$  and so  $\lambda$  is either a skew 1-rectangle, in which case  $\lambda = (n/2, n/2)$  for some even  $n$  and  $m = 0$ , or a skew 1-near rectangle, in which case  $\lambda = (n - k, k)$ , for some  $1 \leq k \leq n/2$  and  $\ell(\lambda) = 2$  and  $m = n - 2k$ . This gives case (i) of the corollary. If, as in (c),  $\ell \geq 2$ , then  $\lambda$  is either a skew  $\ell$ -rectangle, of the form  $(p^{\ell+1})$ , or a skew  $\ell$ -near rectangle; then all but the final column of  $\lambda$  has length  $\ell + 1$  and the final column (which may be the only column) has length either 1 or  $\ell$ . By Lemma 9.11, in the first case  $s_\lambda(1, q, \dots, q^\ell) = q^{\ell n/2}$  and  $m = 0$ ; in the second case,  $s_\lambda(1, q, \dots, q^\ell) = q^{b(\lambda)} + q^{b(\lambda)+1} + \dots + q^{b(\lambda)+\ell}$ , where  $b(\lambda)$  is the minimum weight defined in Definition 2.10, and so  $m = \ell$ . This gives case (ii) in Corollary 1.8.  $\square$

To prove Theorem 9.5 we need the preliminary results in the following subsection.

**9.2. Unimodality of specialized skew Schur functions.** Fix a skew partition  $\lambda/\lambda^*$  of size  $n$ . The minimum weight defined in Definition 2.10 generalizes as follows to skew tableaux.

**Definition 9.6.** We define the *minimum weight* of  $\lambda/\lambda^*$  by

$$b(\lambda/\lambda^*) = \sum_{j=1}^{a(\lambda)} \binom{\lambda'_j - \lambda_{j'}^*}{2}.$$

Equivalently, using the column lengths defined in Definition 9.4,  $b(\lambda/\lambda^*) = \sum_{j=1}^{a(\lambda)} \binom{c(\lambda/\lambda^*)_j}{2}$ . Observe that  $b(\lambda/\lambda^*)$  is the weight of the tableau  $t(\lambda/\lambda^*)$  having entries  $0, 1, \dots, \lambda'_j - 1$  in column  $j$ , for  $1 \leq j \leq a(\lambda)$ . It is easily seen that this tableau is semistandard and has the minimum weight of any tableau in  $\text{SSYT}_{\leq \ell}(\lambda/\lambda^*)$ .

**Lemma 9.7.** *The specialization  $s_{\lambda/\lambda^*}(1, q, \dots, q^\ell)$  is unimodal and centrally symmetric about  $\frac{\ell n}{2}$ .*

*Proof.* Like any symmetric function,  $s_{\lambda/\lambda^*}$  can be expressed as a linear combination of Schur functions labelled by partitions. The lemma therefore follows from the ‘moreover’ part of Theorem 3.4.  $\square$

By Lemma 9.7 and (9.2),  $s_{\lambda/\lambda^*}$  is  $\ell$ -irreducible if and only if

$$(9.3) \quad |\mathcal{S}_{b(\lambda/\lambda^*)}^\ell(\lambda/\lambda^*)| = |\mathcal{S}_{b(\lambda/\lambda^*)+1}^\ell(\lambda/\lambda^*)| = \dots = |\mathcal{S}_{[\ell n/2]}^\ell(\lambda/\lambda^*)| = 1$$

Moreover, if (9.3) holds then  $s_{\lambda/\lambda^*}(1, q, \dots, q^\ell) = q^{b(\lambda/\lambda^*)}(1 + q + \dots + q^m)$  where  $m = \ell n - b(\lambda/\lambda^*)$ . We also obtain the following lemma.

**Lemma 9.8.** *If  $|\mathcal{S}_e^\ell(\lambda/\lambda^*)| < |\mathcal{S}_{e+1}^\ell(\lambda/\lambda^*)|$  then  $e < \frac{\ell n}{2}$ .*

*Proof.* This is immediate from the unimodality property in Lemma 9.7 and (9.2).  $\square$

### 9.3. Bumping and the proof of Theorem 9.5.

**Definition 9.9.** Given  $t \in \text{SSYT}_{\leq \ell}(\lambda/\lambda^*)$  and a box  $(i, j) \in [\lambda/\lambda^*]$ , we define the *bump* of  $t$  in box  $(i, j)$  to be the  $\lambda/\lambda^*$ -tableau  $t^+$  that agrees with  $t$  except in this box, where  $t_{(i,j)}^+ = t_{(i,j)} + 1$ . We say that  $t$  is *bumpable* in box  $(i, j)$  if  $t^+ \in \text{SSYT}_{\leq \ell}(\lambda/\lambda^*)$ .

Equivalently,  $t$  is bumpable in box  $(i, j)$  if and only if  $t_{(i,j)} < \ell$ , and increasing the entry of  $t$  in position  $(i, j)$  by 1 does not violate the semistandard condition. The following example shows the use of Definition 9.9 in the harder ‘only if’ part of the proof of Theorem 9.5.

**Example 9.10.** Let  $\ell = 3$ . Suppose that  $\lambda/\lambda^* = (3^4, 1)/(2)$ , so  $\lambda/\lambda^*$  is a skew 3-near rectangle. Then  $b(\lambda/\lambda^*) = 15$  and

$$\begin{array}{|c|c|c|} \hline & & 0 \\ \hline 0 & 0 & 1 \\ \hline 1 & 1 & 2 \\ \hline 2 & 2 & 3 \\ \hline 3 & & \\ \hline \end{array}, \quad \begin{array}{|c|c|c|} \hline & & 0 \\ \hline 0 & 0 & 1 \\ \hline 1 & 1 & 2 \\ \hline 2 & 3 & 3 \\ \hline 3 & & \\ \hline \end{array}, \quad \begin{array}{|c|c|c|} \hline & & 0 \\ \hline 0 & 0 & 1 \\ \hline 1 & 2 & 2 \\ \hline 2 & 3 & 3 \\ \hline 3 & & \\ \hline \end{array}, \quad \begin{array}{|c|c|c|} \hline & & 0 \\ \hline 0 & 1 & 1 \\ \hline 1 & 2 & 2 \\ \hline 2 & 3 & 3 \\ \hline 3 & & \\ \hline \end{array}$$

are the unique tableaux in  $\mathcal{S}_e^3((3^4, 1)/(2))$  for  $e \in \{15, 16, 17, 18\}$ . The first tableau is  $t(\lambda/\lambda^*)$ , and the rest are obtained by successive bumps in positions  $(4, 2)$ ,  $(3, 2)$  and  $(2, 2)$ . By (9.3),  $s_{(3^4, 1)/(2)}$  is 3-irreducible. Suppose instead that  $\lambda/\lambda^* = (3^4, 1^2)/(2^2)$ . Then  $b(\lambda/\lambda^*) = 13$  and

$$\begin{array}{|c|c|c|} \hline & & 0 \\ \hline & & 1 \\ \hline 0 & 0 & 2 \\ \hline 1 & 1 & 3 \\ \hline 2 & & \\ \hline 3 & & \\ \hline \end{array}, \quad \begin{array}{|c|c|c|} \hline & & 0 \\ \hline & & 1 \\ \hline 0 & 0 & 2 \\ \hline 1 & 2 & 3 \\ \hline 2 & & \\ \hline 3 & & \\ \hline \end{array}, \quad \begin{array}{|c|c|c|} \hline & & 0 \\ \hline & & 1 \\ \hline 0 & 1 & 2 \\ \hline 1 & 2 & 3 \\ \hline 2 & & \\ \hline 3 & & \\ \hline \end{array}, \quad \begin{array}{|c|c|c|} \hline & & 0 \\ \hline & & 1 \\ \hline 0 & 0 & 2 \\ \hline 1 & 3 & 3 \\ \hline 2 & & \\ \hline 3 & & \\ \hline \end{array}$$

are the unique tableaux in  $\mathcal{S}_e^3((3^4, 1^2)/(2^2))$  for  $e \in \{13, 14\}$ , and the two tableaux in  $\mathcal{S}_{15}^3((3^4, 1^2)/(2^2))$ . Again the first tableau is  $t(\lambda/\lambda^*)$ . The second is its bump in position  $(4, 2)$ , and the third and fourth both of weight  $|t(\lambda/\lambda^*)| + 2$  are the bumps of the second in positions  $(3, 2)$  and  $(4, 2)$ , respectively. Since the condition in (9.3) fails,  $s_{(3^4, 1^2)/(2^2)}$  is not 3-irreducible. Note that, as implied by Lemma 9.8,  $b(\lambda/\lambda^*) + 1 < \frac{\ell n}{2}$ , where  $\ell = 3$  and, as usual,  $n = |\lambda/\lambda^*| = 11$ .

*Sufficiency.* To illuminate the condition in Theorem 9.5, we prove a slightly stronger result.

**Lemma 9.11.** *If  $\lambda/\lambda^*$  is a skew  $\ell$ -rectangle, a skew 1-near rectangle, or a skew  $\ell$ -near rectangle where  $\ell \geq 2$  then  $s_{\lambda/\lambda^*}$  is  $\ell$ -irreducible. Moreover,*

$s_{\lambda/\lambda^*}(1, q, \dots, q^\ell)$  is respectively  $q^{\ell n/2}$ ,  $q^{b(\lambda/\lambda^*)} + q^{b(\lambda/\lambda^*)+1} + \dots + q^{b(\lambda/\lambda^*)+d}$  and  $q^{b(\lambda/\lambda^*)} + q^{b(\lambda/\lambda^*)+1} + \dots + q^{b(\lambda/\lambda^*)+\ell}$ .

*Proof.* Write  $c$  for  $c(\lambda/\lambda^*) \in \mathbf{N}^p$ . If  $\lambda/\lambda^*$  is a skew  $\ell$ -rectangle then  $c = (\ell + 1, \dots, \ell + 1)$  and  $b(\lambda/\lambda^*) = p \binom{\ell+1}{2} = p\ell(\ell+1)/2 = \frac{\ell n}{2}$ , so (9.3) obviously holds. By (9.2),  $s_{\lambda/\lambda^*}(1, q, \dots, q^\ell) = q^{\ell n/2}$ .

Suppose that  $\ell = 1$  and  $\lambda/\lambda^*$  is a skew 1-near rectangle of width  $d$ . Let  $y$  be as in Definition 9.4, so  $c_y = \dots = c_{y+d-1} = 1$  and  $c_j = 2$  if  $0 \leq j < y$  or  $y + d \leq j \leq p$ . The minimum weight tableau  $t(\lambda/\lambda^*)$  has entries of 0 in the boxes  $(1, y), \dots, (1, y + d - 1)$ ; all other boxes are in a column  $j$  with  $c_j = 2$ , having entries 0 and 1. More generally, for each  $k$  such that  $0 \leq k \leq d$ , the unique tableau in  $\text{SSYT}_{\leq 1}(\lambda/\lambda^*)$  of weight  $b(\lambda/\lambda^*) + k$  has entries of 0 in the boxes  $(1, y), \dots, (1, y + d - k - 1)$  and entries of 1 in the boxes  $(1, y + d - k), \dots, (1, y + d - 1)$ . Hence (9.3) holds. By (9.2),  $s_{\lambda/\lambda^*}(1, q) = q^{b(\lambda/\lambda^*)} + q^{b(\lambda/\lambda^*)+1} + \dots + q^{b(\lambda/\lambda^*)+d}$ .

Now suppose that  $\ell \geq 2$  and that  $\lambda/\lambda^*$  is a skew  $\ell$ -near rectangle. Let  $z$  be unique such that  $c_z \in \{1, \ell\}$ . Let  $t \in \text{SSYT}_{\leq \ell}(\lambda/\lambda^*)$ . If  $j \neq z$  then since  $c_j = \ell + 1$ , the entries in column  $j$  of  $t$  are  $0, \dots, \ell$ , and  $t$  agrees with  $t(\lambda/\lambda^*)$  in these columns. We now consider the two cases for  $c_z$ .

- (i) When  $c_z = 1$  the unique entry in column  $k$  of  $t$  is determined by  $|t|$ . Moreover  $|t|$  takes all values in  $\{b(\lambda/\lambda^*), \dots, b(\lambda/\lambda^*) + \ell\}$  so by (9.2),  $s_{\lambda/\lambda^*}(1, q, \dots, q^\ell) = q^{b(\lambda/\lambda^*)} + q^{b(\lambda/\lambda^*)+1} + \dots + q^{b(\lambda/\lambda^*)+\ell}$ . In particular (9.3) holds.
- (ii) When  $c_z = \ell$ , we have  $b(\lambda/\lambda^*) = (p-1)\binom{\ell+1}{2} + \binom{\ell}{2} = p\ell(\ell+1)/2 - \ell$  and  $\frac{\ell n}{2} = p\ell(\ell+1)/2 - \ell/2$ . Let  $d \in \{0, 1, \dots, \ell\}$ . The unique tableau in  $\text{SSYT}_{\leq \ell}(\lambda/\lambda^*)$  of weight  $b(\lambda/\lambda^*) + d$  has entries  $\{0, \dots, \ell\} \setminus \{\ell - d\}$  in column  $z$ . Thus again (9.3) holds. A similar argument to (i) shows that  $s_\lambda(1, q, \dots, q^\ell)$  has the required  $\ell + 1$  summands.  $\square$

*Necessity.* The following lemma implies that if  $s_{\lambda/\lambda^*}$  is  $\ell$ -irreducible then  $t(\lambda/\lambda^*)$  has at most one bumpable box.

**Lemma 9.12.** *Let  $B$  be the number of boxes  $(i, j) \in [\lambda/\lambda^*]$  such that  $t(\lambda/\lambda^*)$  is bumpable in box  $(i, j)$ . If  $B \geq 2$  then  $|\mathcal{S}_{b(\lambda/\lambda^*)+1}^\ell(\lambda/\lambda^*)| = B$  and  $b(\lambda/\lambda^*) < \frac{\ell n}{2}$ .*

*Proof.* The first equality is immediate from the definition of bumpable in Definition 9.9. The inequality  $b(\lambda/\lambda^*) < \frac{\ell n}{2}$  now follows by taking  $e = b(\lambda/\lambda^*)$  in Lemma 9.8.  $\square$

**Proposition 9.13.** *Let  $\lambda/\lambda^*$  be a proper skew partition. If  $s_{\lambda/\lambda^*}$  is  $\ell$ -irreducible then either*

- (i)  $c(\lambda/\lambda^*) = (\ell + 1, \dots, \ell + 1)$  or

(ii) *there exists  $k < \ell$  such that  $c(\lambda/\lambda^*) = (\ell + 1, \dots, \ell + 1, k + 1, \dots, k + 1, \ell + 1, \dots, \ell + 1)$  and  $\lambda'$  is constant in the positions in which  $c(\lambda/\lambda^*)$  is  $k + 1$ .*

*Proof.* Suppose that  $s_{\lambda/\lambda^*}$  is  $\ell$ -irreducible. Since  $s_{\lambda/\lambda^*}(1, q, \dots, q^\ell) \neq 0$ , the minimum weight tableau  $t(\lambda/\lambda^*)$  has entries in  $\{0, \dots, \ell\}$ , and so  $c(\lambda/\lambda^*)_j \leq \ell + 1$  for each  $j$ . By Lemma 9.12,  $t(\lambda/\lambda^*)$  is bumpable in at most one box. If (i) does not hold then there exists a column  $j$  such that  $c(\lambda/\lambda^*)_j \leq \ell$ . Take  $y$  minimal with this property and let  $z$  be greatest such that  $c(\lambda/\lambda^*)_y = \dots = c(\lambda/\lambda^*)_z$ . Thus

$$t(\lambda/\lambda^*)_{(\lambda'_y, y)}, \dots, t(\lambda/\lambda^*)_{(\lambda'_z, z)} < \ell.$$

Either  $(\lambda'_z, z+1) \notin [\lambda/\lambda^*]$  or  $c(\lambda/\lambda^*)_{z+1} > c(\lambda/\lambda^*)_z$ . In either case  $t(\lambda/\lambda^*)$  is bumpable in the box  $(\lambda'_z, z)$ . Since  $\lambda'$  is a partition,  $\lambda'_y \geq \dots \geq \lambda'_z$ . Suppose that  $\lambda'_j > \lambda'_{j+1}$  where  $y \leq j < z$ . Then  $(\lambda'_j, j+1) \notin [\lambda/\lambda^*]$  so  $t(\lambda/\lambda^*)$  is bumpable in the box  $(\lambda'_j, j)$ , as well as in the box  $(\lambda'_z, z)$ , a contradiction. Therefore  $\lambda'_y = \dots = \lambda'_z$ . If there exists a column  $j$  such that  $c(\lambda/\lambda^*)_j \leq \ell$  and  $j \notin \{y, \dots, z\}$  then repeating this argument gives another box in which  $t(\lambda/\lambda^*)$  is bumpable, again a contradiction. Therefore  $c(\lambda/\lambda^*)$  is as claimed in (ii).  $\square$

*Proof of Theorem 9.5.* We have already shown the condition is sufficient. Suppose that  $s_{\lambda/\lambda^*}$  is  $\ell$ -irreducible but  $\lambda/\lambda^*$  is not a skew  $\ell$ -rectangle and that  $\lambda/\lambda^*$  is not a skew  $\ell$ -near rectangle. By Proposition 9.13, there exists  $y, z \in \{1, \dots, p\}$  and  $k < \ell$  such that  $c_1 = \dots = c_{y-1} = \ell + 1$ ,  $c_y = \dots = c_z = k + 1$ ,  $c_{z+1} = \dots = c_p = \ell + 1$  and  $\lambda'_y = \dots = \lambda'_z$ . If  $\ell = 1$  then  $\lambda/\lambda^*$  is a 1-near rectangle, as required. Suppose that  $\ell \geq 2$ . Note that  $t(\lambda/\lambda^*)_{(\lambda'_z, z)} = k$  and that  $(\lambda'_z, z)$  is the unique box in which  $t(\lambda/\lambda^*)$  is bumpable. Let  $u$  be the bump of  $t(\lambda/\lambda^*)$  in this box; thus  $\mathcal{S}_{b(\lambda/\lambda^*)+1}^\ell(\lambda/\lambda^*) = \{u\}$ . We consider three cases.

- (a) Suppose that  $1 \leq k < \ell - 1$ . (This is the case in the second example in Example 9.10.) Since  $u_{(\lambda'_z, z)} = k + 1 < \ell$  and either  $u_{(\lambda'_z, z+1)} = \ell$  or  $(\lambda'_z, z+1) \notin [\lambda/\lambda^*]$ ,  $u$  is bumpable in position  $(\lambda'_z, z)$ . Similarly, either  $u_{(\lambda'_z-1, z+1)} \geq \ell - 1$  or  $(\lambda'_z - 1, z+1) \notin [\lambda/\lambda^*]$ . Therefore  $u$  is bumpable in box  $(\lambda'_z - 1, z)$ . Thus  $|\mathcal{S}_{b(\lambda/\lambda^*)+2}^\ell(\lambda/\lambda^*)| \geq 2$  and since  $|\mathcal{S}_{b(\lambda/\lambda^*)+1}^\ell(\lambda/\lambda^*)| = 1$ , it follows from Lemma 9.8 that  $b(\lambda/\lambda^*) + 1 < \frac{\ell n}{2}$ . Therefore (9.3) does not hold.
- (b) Suppose that  $k = \ell - 1$ . Since  $\lambda/\lambda^*$  is not a skew  $\ell$ -near rectangle, we have  $y < z$ . As in (a),  $u$  is bumpable in position  $(\lambda'_z - 1, z)$ . Moreover, since  $\lambda'_{z-1} = \lambda'_z$  and  $c_{z-1} = c_z$ , we have  $u_{(\lambda'_{z-1}, z-1)} = \ell - 1$  and so  $u$  is bumpable in position  $(\lambda'_{z-1}, z - 1)$ . Thus  $|\mathcal{S}_{b(\lambda/\lambda^*)+2}^\ell(\lambda/\lambda^*)| \geq 2$  and as in (a) we conclude that (9.3) does not hold.



- (c) Suppose  $k = 0$ . Then  $u_{(\lambda'_z, z)} = 1$  and box  $(\lambda'_z, z)$  is bumpable as  $\ell \geq 2$ . But if  $y < z$  then box  $(\lambda'_z, z - 1)$  is also bumpable in  $u$ , giving that  $|\mathcal{S}_{b(\lambda/\lambda^*)+2}^\ell(\lambda/\lambda^*)| \geq 2$  and (9.3) again fails to hold.

This completes the proof.  $\square$

## 10. TWO ROW, TWO COLUMN AND HOOK EQUIVALENCES

We say that a partition of hook shape  $(a + 1, 1^b)$  is *proper* if  $a, b \in \mathbf{N}$ .

**Theorem 10.1.** *Let  $\lambda$  and  $\mu$  be partitions that each, separately, have either precisely two rows, precisely two columns or are of proper hook shape. Let  $\ell, m \in \mathbf{N}$  be such that  $\ell \geq \ell(\lambda)$  and  $m \geq \ell(\mu)$ . Then all plethystic equivalences  $\lambda \ell \sim_m \mu$  are listed in one of the cases in Table 1.*

*Proof.* The proofs for each family in Table 1 are similar. We illustrate the method by finding all plethystic equivalences between a two-row non-hook partition  $\lambda = (a, b)$  and a proper hook  $\mu = (c + 1, 1^d)$ . By our assumption,  $\ell \geq 2$  and  $m \geq d + 1$ . By Lemma 4.2 and Theorem 1.3 we may assume that  $c \geq d$ . By Theorem 3.4(h),  $\lambda \ell \sim_m \mu$  if and only if there is an equality of multisets  $(C(\lambda) + \ell + 1) \cup H(\mu) = (C(\mu) + m + 1) \cup H(\lambda)$ . Equivalently,

$$\left\{ \begin{array}{l} \ell + 1, \dots, \ell + a, \\ \ell, \dots, \ell + b - 1, \\ 1, \dots, d, 1 \dots, c, \\ c + d + 1 \end{array} \right\} = \left\{ \begin{array}{l} m - d + 1, \dots, m + c + 1, \\ 1, \dots, b, \\ 1 \dots, a - b, a - b + 2, \dots, a + 1 \end{array} \right\}.$$

Comparing the greatest element of each side as in Proposition 4.7 shows that if equality holds then  $\ell + a = m + c + 1$ , that is  $m = \ell + a - c - 1$ . Substituting for  $m$  using this relation, and inserting  $a - b + 1$  into each multisubset, we find that  $\lambda \ell \sim_{\ell+a-c-1} \mu$  if and only if

$$(10.1) \quad \left\{ \begin{array}{l} \ell + 1, \dots, \ell + a, \\ \ell, \dots, \ell + b - 1, \\ 1, \dots, d, 1 \dots, c, \\ c + d + 1, a - b + 1 \end{array} \right\} = \left\{ \begin{array}{l} \ell + a - c - d, \dots, \ell + a, \\ 1, \dots, b, \\ 1 \dots, a + 1 \end{array} \right\}.$$

Firstly consider the case when  $a - c - d \geq 1$ . We may cancel the elements  $\ell + a - c - d, \dots, \ell + a$  from each side to get that  $\lambda \ell \sim_{\ell+a-c-1} \mu$  if and only if

$$\left\{ \begin{array}{l} \ell + 1, \dots, \ell + a - c - d - 1, \\ \ell, \dots, \ell + b - 1, \\ 1, \dots, d, 1 \dots, c, \\ c + d + 1, a - b + 1 \end{array} \right\} = \left\{ \begin{array}{l} 1, \dots, b, \\ 1, \dots, a + 1 \end{array} \right\}.$$

We claim that this multiset equality implies  $a - c - d \leq b$ . Indeed, if  $a - c - d > b$  then, on the left hand side,  $\ell + 1 \leq \ell + b - 1 < \ell + a - c - d - 1$ . Therefore the multiplicity of  $\ell + b - 1$  is two, and comparing with the multiset on the right shows that  $\ell = 1$ , contrary to our initial assumption.

---

*Equivalences between proper hook partitions:  $b \geq 1, \ell \geq b - 1$*

(a)  $(a + 1, 1^b)_\ell \sim_\ell (a + 1, 1^b)$   
(b)  $(a + 1, 1^b)_\ell \sim_{\ell+a-b} (b + 1, 1^a)$  (conjugate, Theorem 1.3)

---

*Equivalences between two-row non-hook partitions:  $a \geq b \geq 2$*

(c)  $(a, b)_\ell \sim_\ell (a, b)$   
(d)  $(a, a)_{c+1} \sim_{a+1} (c, c)$  (rectangular, Theorem 1.6),  $c \geq 2$   
(e)  $(a, b)_2 \sim_2 (a, a - b)$  (complement, Theorem 1.5),  $a - b \geq 2$   
(f)  $(2\ell, \ell + 2)_\ell \sim_{\ell+2} (2\ell - 2, \ell - 2)$   $\ell \geq 4$

---

*Equivalences between two-column non-hook partitions:  $a \geq 2, c \geq 2$*

(g)  $(2^a, 1^b)_\ell \sim_\ell (2^a, 1^b)$   
(h)  $(2^a)_{a-1} \sim_{c-1} (2^c)$  (rectangular, Theorem 1.6)  
(i)  $(2^a, 1^b)_{a+b+c-1} \sim_{a+b+c-1} (2^c, 1^b)$  (complement, Theorem 1.5)

---

*Equivalences between a two-row non-hook and a proper hook partition*

(j)  $(a, b)_{a-b+1} \sim_a (a - b + 1, 1^b)$   $a \geq b \geq 2$   
(j')  $(a, b)_{a-b+1} \sim_{2(a-b)} (b + 1, 1^{a-b})$   $a \geq b \geq 2$   
(k)  $(3\ell - 3, 2\ell - 1)_\ell \sim_{3\ell-4} (\ell + 1, 1^{\ell-2})$   $\ell \geq 3$   
(k')  $(3\ell - 3, 2\ell - 1)_\ell \sim_{3\ell-2} (\ell - 1, 1^\ell)$   $\ell \geq 2$

---

*Equivalences between a two-column non-hook and a proper hook partition:  $a \geq 2$*

(l)  $(2^a, 1^b)_{a+b} \sim_{a+b} (2, 1^b)$  (complement, Theorem 1.5),  $b \geq 1$   
(m)  $(2^a, 1^c)_{a+c} \sim_{a+1} (c + 1, 1)$   $c \geq 1$

---

*Equivalences between a two-row and a two-column partition both non-hooks:  $a \geq 2$*

(n)  $(a, a)_\ell \sim_{\ell+a-2} (2^a)$  (conjugate, Theorem 1.3),  $\ell \geq 1$   
(o)  $(a, a)_{b+1} \sim_{a+b-1} (2^b)$  (rectangular, Theorem 1.6),  $b \geq 2$   
(p)  $(6, 5)_3 \sim_7 (2^4, 1^3)$ .

---

TABLE 1. All plethystic equivalences between partitions that, separately, have either precisely two rows, precisely two columns, or are of proper hook shape. In cases (j), (j') and (k), (k') the two hook partitions on the right are conjugates.

As  $a - c - d \leq b$ , we may compare greatest elements of the above multisets to show that  $a + 1 = \ell + b - 1$ , that is  $\ell = a - b + 2$ . We substitute for  $\ell$  using this relation and cancel the elements

$$\{a - b + 1, \ell, \dots, \ell + b - 1\} = \{a - b + 1, a - b + 2, \dots, a + 1\}$$

from each side to reduce to

$$\left\{ \begin{array}{l} a - b + 3, \dots, 2a - b - c - d + 1, \\ 1, \dots, d, 1 \dots, c, \\ c + d + 1 \end{array} \right\} = \left\{ \begin{array}{l} 1, \dots, b, \\ 1 \dots, a - b \end{array} \right\}.$$

Since  $c + d + 1 \geq c + 2 \geq d + 2$ , for the multiset on the left to equal a union of two intervals each containing 1, we must have  $c = a - b + 2$  and  $d = a - b$ . Then we have an equality of multisets if and only if  $c + d + 1 = b$ . We obtain the case with  $c \geq d$  in (k), namely

$$(3\ell - 3, 2\ell - 1)_{\ell \sim 3\ell - 4} (\ell + 1, 1^{\ell - 2}).$$

In the remaining case  $a - c - d \leq 0$ , and so  $c + d \geq a \geq b$ . We cancel the elements  $\ell + 1, \dots, \ell + a$  from each side in (10.1) to see that  $\lambda_{\ell \sim \ell + a - c - 1} \mu$  if and only if

$$\left\{ \begin{array}{l} \ell, \dots, \ell + b - 1, \\ 1, \dots, d, 1 \dots, c, \\ c + d + 1, a - b + 1 \end{array} \right\} = \left\{ \begin{array}{l} \ell + a - c - d, \dots, \ell, \\ 1, \dots, b, \\ 1 \dots, a + 1 \end{array} \right\}.$$

Since  $b \geq 2$ , the element  $\ell + 1$  lies in the left hand side. Hence the greatest element of the right hand side is  $a + 1$  rather than  $\ell$ . But  $a + 1 \leq c + d + 1$  which appears on the left; hence  $a = c + d$ , and on the right  $\{\ell + a - c - d, \dots, \ell\} = \{\ell\}$ . After cancelling  $\{\ell, c + d + 1\} = \{\ell, a + 1\}$  from each side, the multiset equation becomes

$$\left\{ \begin{array}{l} \ell + 1, \dots, \ell + b - 1, \\ 1, \dots, d, 1 \dots, c, \\ c + d - b + 1 \end{array} \right\} = \left\{ \begin{array}{l} 1, \dots, b, \\ 1 \dots, c + d \end{array} \right\}.$$

Since  $b \geq 2$ , and  $c + d$  is in the right-hand side, if equality holds then the greatest element on the left-hand side is not  $c + d - b + 1$ . Hence it is  $\ell + b - 1 = c + d$  and

$$\left\{ \begin{array}{l} c + d - b + 2, \dots, c + d, \\ 1, \dots, d, 1 \dots, c, \\ c + d - b + 1 \end{array} \right\} = \left\{ \begin{array}{l} 1, \dots, b, \\ 1 \dots, c + d \end{array} \right\}.$$

Either  $c + d - b + 1 = c + 1$  and  $d = b$ , or  $c + d - b + 1 = d + 1$  and  $c = b$ . Using that  $a = c + d$  we have  $c = a - b$ ,  $d = b$  or  $c = b$ ,  $d = a - b$ , respectively. The corresponding plethystic equivalences are  $(a, b)_{a-b+1} \sim_a (a - b + 1, 1^b)$  and  $(a, b)_{a-b+1} \sim_{2(a-b)} (b + 1, 1^{a-b})$ , respectively, as in (j).  $\square$

We remark that the Haskell [27] software `HookContent.hs` available from the second author's website<sup>2</sup> was used to discover many of the equivalences appearing in Table 1. It has also been used to verify the more fiddly part of the authors' proof, by showing that every plethystic equivalence between two partitions of the types above, each of size at most 30, appears in our

<sup>2</sup>See [www.ma.rhul.ac.uk/~uvah099/](http://www.ma.rhul.ac.uk/~uvah099/)

classification. Finally we observe that it follows from Proposition 3.6 and elementary number-theoretic arguments that the only plethystic equivalences in Table 1 involving distinct partitions that lift to isomorphisms of  $\mathrm{GL}_2(\mathbf{C})$ -representations are the infinite families

$$\left(\frac{d(d+1)}{2} - 1, \frac{d(d-1)}{2}\right) \sim_{2(d-1)} \left(\frac{d(d-1)}{2} + 1, 1^{d-1}\right);$$

for  $d > 2$  from the second case in (j), and  $(b(b-1), b(b-1)) \sim_{b^2-1} (2^b)$  for  $b > 2$  from (o).

## 11. EQUAL DEGREE EQUIVALENCES

Let  $\lambda$  be a partition. By Theorem 1.5 we have  $\lambda \sim_{\ell} \lambda^{\circ(\ell+1)}$  for any  $\ell \geq \ell(\lambda)$ , where  $\lambda^{\circ(\ell+1)}$  denotes the complement of  $\lambda$  in the  $(\ell+1) \times a(\lambda)$  box. We say that a plethystic equivalence  $\lambda \sim_{\ell} \mu$ , where  $\ell \geq \ell(\mu)$ , is *exceptional* if  $\lambda \neq \mu$  and  $\lambda^{\circ(\ell+1)} \neq \mu$ . Thus Theorem 1.10 asserts that there are exceptional equivalences if and only if  $\ell \geq 5$ .

**11.1. Ruling out exceptional equivalences.** To prove Theorem 1.10(a) we use Theorem 3.4(i), that  $\lambda \sim_{\ell} \mu$  if and only if  $\Delta_{\ell}(\lambda) = \Delta_{\ell}(\mu)$ . Recall that the differences  $\delta(\lambda)_j = \lambda_j - \lambda_{j+1} + 1$  and the multiset  $\Delta_{\ell}(\lambda) = \{\delta(\lambda)_j + \dots + \delta(\lambda)_{k-1} : 1 \leq j < k \leq \ell+1\}$  were defined in Definition 2.13. From the definition of  $\lambda^{\circ r}$  before Theorem 1.5, we have

$$\delta(\lambda^{\circ r})_j = (a(\lambda) - \lambda_{r+1-j}) - (a(\lambda) - \lambda_{r-j}) + 1 = \lambda_{r-j} - \lambda_{r+1-j} + 1 = \delta(\lambda)_{r-j}$$

and so the difference sequence  $(\delta(\lambda^{\circ(\ell+1)})_1, \dots, \delta(\lambda^{\circ(\ell+1)})_{\ell})$  for  $\lambda^{\circ(\ell+1)}$  is the reverse of the difference sequence  $(\delta(\lambda)_1, \dots, \delta(\lambda)_{\ell})$  for  $\lambda$ . Thus, as expected, the multisets  $\Delta_{\ell}(\lambda)$  and  $\Delta_{\ell}(\lambda^{\circ(\ell+1)})$  agree. For the small  $\ell$  cases, it is surprisingly useful that this multiset determines the minimum weight  $b(\lambda)$  defined in Definition 2.10. To prove this we use the following statistic: let

$$d(\lambda) = \sum_{j=1}^{\ell} \frac{j(\ell+1-j)}{2} \delta(\lambda)_j - \frac{1}{2} \binom{\ell+2}{3}.$$

**Lemma 11.1.** *Let  $\lambda$  be a partition of  $n$  such that  $\ell \geq \ell(\lambda)$ . Then  $-\frac{\ell n}{2} + b(\lambda) = -d(\lambda)$ .*

*Proof.* We have  $\lambda_i = \delta_i(\lambda) + \dots + \delta_{\ell}(\lambda) - (\ell - i + 1)$  for  $1 \leq i \leq \ell$ . Hence the coefficient of  $\delta(\lambda)_j$  in  $\sum_{i=1}^{\ell} \lambda_i$  is  $j$  and we have

$$n = \sum_{j=1}^{\ell} j \delta(\lambda)_j - \sum_{j=1}^{\ell} (\ell - j + 1) = \sum_{j=1}^{\ell} j \delta(\lambda)_j - \binom{\ell+1}{2}.$$

Similarly, since  $b(\lambda) = \sum_{i=1}^{\ell} (i-1) \lambda_i$ , the coefficient of  $\delta(\lambda)_j$  in  $b(\lambda)$  is  $\sum_{i=1}^j (i-1) = \binom{j}{2}$  and, using  $\sum_{i=1}^{\ell} (i-1)(\ell-i+1) = \sum_{k=1}^{\ell-1} k(\ell-k) =$

$\frac{1}{2}\ell^2(\ell-1) - \frac{1}{6}\ell(\ell-1)(2\ell-1) = \binom{\ell+1}{3}$  we have

$$b(\lambda) = \sum_{j=1}^{\ell} \binom{j}{2} \delta(\lambda)_j - \binom{\ell+1}{3}.$$

The result now follows from the two displayed equations.  $\square$

*Proof of Theorem 1.10(a).* By Theorem 3.4(i) if  $\lambda \underset{\ell}{\sim} \mu$  then  $\Delta_{\ell}(\lambda) = \Delta_{\ell}(\mu)$ . By the final part of this theorem,  $-\frac{\ell|\lambda|}{2} + b(\lambda) = -\frac{\ell|\mu|}{2} + b(\mu)$ . Hence by Lemma 11.1, we also have  $d(\lambda) = d(\mu)$ .

For  $1 \leq j \leq \ell$ , let  $\delta_j = \delta(\lambda)_j$  and let  $\varepsilon_j = \delta(\mu)_j$ . Observe that the greatest elements of  $\Delta_{\ell}(\lambda)$  and  $\Delta_{\ell}(\mu)$  are  $\delta_1 + \cdots + \delta_{\ell} = \lambda_1 + \ell$  and  $\varepsilon_1 + \cdots + \varepsilon_{\ell} = \mu_1 + \ell$ , respectively. Hence, as also follows from Proposition 4.7, we have

$$(11.1) \quad \delta_1 + \cdots + \delta_{\ell} = \varepsilon_1 + \cdots + \varepsilon_{\ell}.$$

If  $\ell = 1$  then  $\lambda_1 = \delta_1 = \varepsilon_1 = \mu_1$  and  $\lambda = \mu$  as required. If  $\ell \geq 2$  then the least two elements of  $\Delta_{\ell}(\lambda)$  are  $\delta_c$  and  $\delta_{c'}$  for some distinct  $c$  and  $c'$ , and similarly for  $\Delta_{\ell}(\mu)$ . Hence the multisubsets of the least two elements in  $\Delta_{\ell}(\lambda)$  and  $\Delta_{\ell}(\mu)$  agree.

Suppose that  $\ell = 2$ . We have just seen that  $\{\delta_1, \delta_2\} = \{\varepsilon_1, \varepsilon_2\}$ . This is the case if and only if  $\lambda = \mu$  or  $\lambda = \mu^{\circ 3}$ .

Suppose that  $\ell = 3$ . The multisets  $\{\delta_1, \delta_2, \delta_3\}$  and  $\{\varepsilon_1, \varepsilon_2, \varepsilon_3\}$  have the same least two elements, and, by (11.1), the same sum. Hence they are equal. By Lemma 11.1,  $3\delta_1 + 4\delta_2 + 3\delta_3 = 3\varepsilon_1 + 4\varepsilon_2 + 3\varepsilon_3$ . Hence, again using (11.1), we have  $\delta_2 = \varepsilon_2$ . Now either  $\delta_1 = \varepsilon_1$ , and so  $(\delta_1, \delta_2, \delta_3) = (\varepsilon_1, \varepsilon_2, \varepsilon_3)$  and  $\lambda = \mu$ , or  $\delta_1 = \varepsilon_3$  and so  $(\delta_1, \delta_2, \delta_3) = (\varepsilon_3, \varepsilon_2, \varepsilon_1)$  and  $\lambda = \mu^{\circ 4}$ .

Suppose that  $\ell = 4$ . By replacing  $\lambda$  and  $\mu$  with their complements if necessary, we may assume that  $\delta_1 \leq \delta_4$  and  $\varepsilon_1 \leq \varepsilon_4$ . By Lemma 11.1,  $2\delta_1 + 3\delta_2 + 3\delta_3 + 2\delta_4 = 2\varepsilon_1 + 3\varepsilon_2 + 3\varepsilon_3 + 2\varepsilon_4$ . Hence by (11.1) we have

$$(11.2) \quad \delta_1 + \delta_4 = \varepsilon_1 + \varepsilon_4 \text{ and } \delta_2 + \delta_3 = \varepsilon_2 + \varepsilon_3.$$

Since  $\delta_1 \leq \delta_4$ , after  $\delta_1 + \delta_2 + \delta_3 + \delta_4$ , the second greatest element of  $\Delta_4(\lambda)$  is  $\delta_2 + \delta_3 + \delta_4$ . Similarly the second greatest element of  $\Delta_4(\mu)$  is  $\varepsilon_2 + \varepsilon_3 + \varepsilon_4$ . Therefore  $\delta_1 = \varepsilon_1$  and so by (11.2),  $\delta_4 = \varepsilon_4$ . Cancelling the equal elements  $\delta_2 + \delta_3 = \varepsilon_2 + \varepsilon_3$ ,  $\delta_1 + \delta_2 + \delta_3 = \varepsilon_1 + \varepsilon_2 + \varepsilon_3$ ,  $\delta_2 + \delta_3 + \delta_4 = \varepsilon_2 + \varepsilon_3 + \varepsilon_4$  and  $\delta_1 + \delta_2 + \delta_3 + \delta_4 = \varepsilon_1 + \varepsilon_2 + \varepsilon_3 + \varepsilon_4$  from the multisets  $\Delta_4(\lambda)$  and  $\Delta_4(\mu)$  we obtain

$$(11.3) \quad \{\delta_2, \delta_3, \delta_1 + \delta_2, \delta_3 + \delta_4\} = \{\varepsilon_2, \varepsilon_3, \delta_1 + \varepsilon_2, \varepsilon_3 + \delta_4\}.$$

The least element on the left is either  $\delta_2$  or  $\delta_3$ , and the least element on the right is either  $\varepsilon_2$  or  $\varepsilon_3$ . If  $\delta_2 = \varepsilon_2$  then from (11.2) we get  $\delta_3 = \varepsilon_3$ . Hence  $(\delta_1, \delta_2, \delta_3, \delta_4) = (\varepsilon_1, \varepsilon_2, \varepsilon_3, \varepsilon_4)$  and  $\lambda = \mu$ . A symmetric argument, swapping 2 and 3, applies if  $\delta_3 = \varepsilon_3$ . In the remaining case we may suppose, by swapping  $\lambda$  and  $\mu$  if necessary, that  $\delta_2 = \varepsilon_3$ . From (11.2) we get  $\delta_3 = \varepsilon_2$ . Hence  $(\delta_1, \delta_2, \delta_3, \delta_4) = (\varepsilon_1, \varepsilon_3, \varepsilon_2, \varepsilon_4)$ . From (11.3) we now get  $\{\delta_1 + \delta_2, \delta_3 +$

$\delta_4\} = \{\delta_1 + \delta_3, \delta_2 + \delta_4\}$ . Hence either  $\delta_2 = \delta_3$  and  $\lambda = \mu$  or  $\delta_1 = \delta_4$  and  $\lambda = \mu^{\circ 5}$ .

□

**11.2. Existence of exceptional equivalences.** To prove Theorem 1.10(b) we use the pyramid notation seen in Example 2.16, applied to the following partitions.

**Definition 11.2.** For  $m, \ell \in \mathbf{N}_0$  with  $\ell \geq 5$  we define  $\lambda_{\ell m}$  and  $\mu_{\ell m}$  by

$$\lambda_{\ell m} = \begin{cases} (8 + 5m, 7 + 4m, 2 + 2m, 2 + m) & \text{if } \ell = 5 \\ (6 + m, 4 + m, 3 + m, 3 + m, 3) & \text{if } \ell = 6 \\ (6 + m, 4 + m, 4 + m, 3 + m, 3 + m, 3) & \text{if } \ell = 7 \\ (5 + m, 4 + m, (3 + m)^4, 3, 1^{\ell-8}) & \text{if } \ell \geq 8 \end{cases}$$

and

$$\mu_{\ell m} = \begin{cases} (8 + 5m, 6 + 4m, 3 + 2m, m) & \text{if } \ell = 5 \\ (6 + m, 3 + m, 3 + m, 3, 1) & \text{if } \ell = 6 \\ (6 + m, 3 + m, 3 + m, 3, 1, 1) & \text{if } \ell = 7 \\ (5 + m, (3 + m)^{\ell-8}, 2 + m, 2 + m, 2, 1) & \text{if } \ell \geq 8. \end{cases}$$

The partition  $\mu_{60}$  is the lexicographically least partition in an exceptional equivalence when  $\ell = 6$ . The other partitions were discovered by a computer search using the software already mentioned. The special case  $\ell = 5$  and  $m = 0$  of the following proposition was seen in Example 2.16.

**Proposition 11.3.** *For all  $m \in \mathbf{N}_0$  and  $\ell \geq 5$  there is an exceptional equivalence  $\lambda_{\ell m} \sim_{\ell} \mu_{\ell m}$ .*

*Proof.* It is clear from Definition 11.2 that  $\lambda_{\ell m} \neq \mu_{\ell m}$  for any  $\ell$  and  $m$ . Moreover, since the second part in each  $\mu_{\ell m}$  is strictly smaller than  $a(\mu_{\ell m})$ , each partition  $\mu_{\ell m}^{\circ(\ell+1)}$  has precisely  $\ell$  parts. Since each partition  $\lambda_{\ell m}$  has precisely  $\ell - 1$  parts, it follows that  $\lambda_{\ell m} \neq \mu_{\ell m}^{\circ(\ell+1)}$  for any  $k$  and  $\ell$ . To proceed further, it is most convenient to work with the complementary partitions  $\eta_{\ell m} = \mu_{\ell m}^{\circ(\ell+1)}$ . By Theorem 1.5 and Theorem 3.4(i), it suffices to prove that  $\Delta_{\ell}(\lambda_{\ell m}) = \Delta_{\ell}(\eta_{\ell m})$  for all  $\ell$  and  $m$ .

For small  $\ell$  this is a routine verification using the pyramid notation seen in Example 2.16. To illustrate the method we take  $\ell = 8$ . It will be useful to say that a pyramid entry *involves*  $m$  if it of the form  $c + m$  for some  $c \in \mathbf{N}$ . The difference sequences for  $\lambda_{\ell m}$  and  $\eta_{\ell m}$  are

$$\begin{aligned} & (2, 2, 1, 1, 1, 1 + m, 3, 1^{\ell-9}, 2, 1) \\ & (1, 1, 1, 2, 2, 1 + m, 1, 2, 1^{\ell-9}, 3), \end{aligned}$$

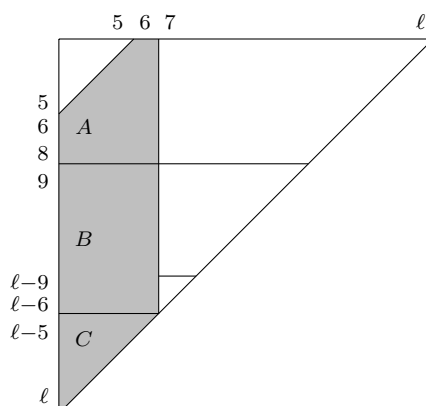

FIGURE 6. Partition of the pyramids for  $\lambda_{\ell m}$  and  $\eta_{\ell m}$ . The important row and column numbers are indicated; an entry involves  $m$  if and only if it is in the shaded region.

respectively. When  $\ell = 8$ , the corresponding pyramids are

2	2	1	1	1	$1+m$	4	1	1	1	2	2	$1+m$	1	4
4	3	2	2	$2+m$	$5+m$	5	2	2	3	4	$3+m$	$2+m$	5	
5	4	3	$3+m$	$6+m$	$6+m$		3	4	5	$5+m$	$4+m$	$6+m$		
6	5	$4+m$	$7+m$	$7+m$			5	6	$6+m$	$6+m$	$8+m$			
7	$6+m$	$8+m$	$8+m$				7	$7+m$	$7+m$	$10+m$				
$8+m$	$10+m$	$9+m$					$8+m$	$8+m$	$11+m$					
$12+m$	$11+m$						$9+m$	$12+m$						
$13+m$							$13+m$							

Note that the entries involving  $m$  lie in the same positions. This helps one to see that in either case the multiset of pyramid entries is

$$\{1^4, 2^4, 3^2, 4^3, 5^3, 6, 7\} \cup (\{1, 2, 3, 4, 5, 6^3, 7^2, 8^3, 9, 10, 11, 12, 13\} + m).$$

Similarly one can check that  $\Delta_\ell(\lambda_{\ell k}) = \Delta_\ell(\eta_{\ell k})$  for all  $k \in \mathbf{N}_0$  and all  $\ell$  such that  $5 \leq \ell \leq 18$ . This can be done programmatically using the MATHEMATICA [16] notebook `ExceptionalEquivalences.nb` available from the second author's website.

For the generic case when  $\ell \geq 18$  we partition the pyramids  $P$  and  $Q$  for  $\lambda_{\ell m}$  and  $\eta_{\ell m}$  as shown in Figure 6. Using the calculation rule from §2.7 one finds that the first 8 rows of the pyramid  $P$  for  $\lambda_{\ell m}$  are

2	2	1	1	1	$1+m$	3	1	$\ell-9$	1	2	1
4	3	2	2	$2+m$	$4+m$	4	2	$\ell-10$	2	3	3
5	4	3	$3+m$	$5+m$	$5+m$	5	3	$\ell-11$	3	4	4
6	5	$4+m$	$6+m$	$6+m$	$6+m$	6	4	$\ell-12$	4	5	5
7	$6+m$	$7+m$	$7+m$	$7+m$	$7+m$	7	5	$\ell-13$	5	6	6
$8+m$	$9+m$	$8+m$	$8+m$	$8+m$	$8+m$	8	6	$\ell-14$	6	7	7
$11+m$	$10+m$	$9+m$	$9+m$	$9+m$	$9+m$	9	7	$\ell-15$	7	8	8
$12+m$	$11+m$	$10+m$	$10+m$	$10+m$	$10+m$	10	8	$\ell-16$	8	9	9

where in each case the notation  $c \cdot^m$  indicates  $m$  consecutive entries of  $c$ . Similarly, the first 8 rows of the pyramid  $Q$  for  $\eta m \ell$  are

1	1	1	2	2	$1+m$	1	2	1	$\ell-9$	1	3
2	2	3	4	$3+m$	$2+m$	3	3	2	$\ell-10$	2	4
3	4	5	$5+m$	$4+m$	$4+m$	4	4	3	$\ell-11$	3	5
5	6	$6+m$	$6+m$	$6+m$	$5+m$	5	5	4	$\ell-12$	4	6
7	$7+m$	$7+m$	$8+m$	$7+m$	$6+m$	6	6	5	$\ell-13$	5	7
$8+m$	$8+m$	$9+m$	$9+m$	$8+m$	$7+m$	7	7	6	$\ell-14$	6	8
$9+m$	$10+m$	$10+m$	$10+m$	$9+m$	$8+m$	8	8	7	$\ell-15$	7	9
$11+m$	$11+m$	$11+m$	$11+m$	$10+m$	$9+m$	9	9	8	$\ell-16$	8	10

Observe that if  $r \leq 5$  then the multisets of entries of  $P$  and  $Q$  in row  $r$  not involving  $m$  are the same. Moreover, it is easily proved by induction on  $r$  that if  $6 \leq r \leq \ell-9$  then the entries of  $P$  and  $Q$  in row  $r$  not involving  $m$  are  $r+2, r, r, r, r+1, r+1$  and  $r+1, r+1, r, r, r+2$ , respectively. As can be seen from Figure 6, the remaining entries in  $P$  and  $Q$  not involving  $m$  lie in rows  $\ell-9, \ell-8, \ell-7$  and  $\ell-6$  and columns 7, 8, 9, 10. They are

$\ell-9$	$\ell-11$	$\ell-11$	$\ell-11$	$\ell-10$	$\ell-10$	$\ell-10$	$\ell-10$	$\ell-11$	$\ell-11$	$\ell-11$	$\ell-9$
$\ell-8$	$\ell-10$	$\ell-10$	$\ell-9$	$\ell-9$		$\ell-9$	$\ell-9$	$\ell-10$	$\ell-10$	$\ell-8$	
$\ell-7$	$\ell-9$	$\ell-8$	$\ell-8$			$\ell-8$	$\ell-8$	$\ell-9$	$\ell-7$		
$\ell-6$	$\ell-7$	$\ell-7$				$\ell-7$	$\ell-7$	$\ell-6$			
$\ell-4$	$\ell-6$					$\ell-6$	$\ell-4$				
$\ell-3$						$\ell-3$					

where the first two rows shows the known entries from rows  $\ell-11, \ell-10$  needed to compute the following rows. Three exceptional entries are highlighted. Again the multisets of entries agree row by row. Hence the multisets of entries in  $P$  and  $Q$  agree on entries not involving  $m$ . We note for later use that, from the pyramids immediately above,

$$(11.4) \quad P_7^{(r)} = r+2 \text{ and } Q_7^{(r)} = r+1 \text{ if } 8 \leq r \leq \ell-8$$

and  $P_7^{(\ell-7)} = \ell-4, P_7^{(\ell-6)} = \ell-3, Q_7^{(\ell-7)} = \ell-6$  and  $Q_7^{(\ell-6)} = \ell-3$ .

We now consider entries involving  $m$ . For  $1 \leq r \leq \ell$ , let  $\mathcal{P}^{(r)} + m$  and  $\mathcal{Q}^{(r)} + m$  be the multisets of entries in row  $r$  of  $P$  and  $Q$  involving  $m$ . Comparing the 33 entries involving  $m$  in rows  $r$  for  $1 \leq r \leq 8$  (region  $A$  in Figure 6) we find that

$$(11.5) \quad \bigcup_{r=1}^8 \mathcal{P}^{(r)} / \bigcup_{r=1}^8 \mathcal{Q}^{(r)} = \{4, 2\} / \{3, 3\} + 8.$$

If  $8 \leq r \leq \ell-6$  then the entries involving  $k$  in row  $r$  are precisely those in region  $B$ , lying in the first six columns of the pyramids. Let  $\mathbf{p}^{(r)}$  and  $\mathbf{q}^{(r)}$  be the 6-tuples defined by  $\mathbf{p}_j^{(r)} = P_j^{(r)} - m$  and  $\mathbf{q}_j^{(r)} = Q_j^{(r)} - m$ , respectively. An induction on  $r$ , using (11.4) to find the entries in column 6, shows that if  $8 \leq r \leq \ell-7$  then

$$\mathbf{p}^{(r)} = (4+r, 3+r, 2+r, 2+r, 2+r, 2+r)$$



$$\mathbf{q}^{(r)} = (3 + r, 3 + r, 3 + r, 3 + r, 2 + r, 1 + r).$$

(We stop at  $\ell - 7$  because of the exceptional entry  $P_7^{(\ell-7)}$ .) The corresponding difference multiset is  $\{4, 2, 2, 2\}/\{3, 3, 3, 1\} + r$ . We now claim that

$$(11.6) \quad \bigcup_{r=1}^s \mathcal{P}^{(r)} / \bigcup_{r=1}^s \mathcal{Q}^{(r)} = \{4, 2\}/\{3, 3\} + s$$

for  $8 \leq s \leq \ell - 7$ . Indeed, when  $s = 8$  this follows from (11.5), and the inductive step is immediate from  $(\{4, 2\}/\{3, 3\} + s) \cup (\{4, 2, 2, 2\}/\{3, 3, 3, 1\} + s + 1) = \{4, 2\}/\{3, 3\} + (s + 1)$ . Using the exceptional entries  $P_7^{(\ell-7)} = \ell - 4$  and  $Q_7^{(\ell-7)} = \ell - 3$  seen after (11.4), we have  $\mathbf{p}^{(r)} = (4 + r, 3 + r, 2 + r, 2 + r, 2 + r, 3 + r)$  and  $\mathbf{q}^{(r)} = (3 + r, 3 + r, 3 + r, 3 + r, 2 + r, 1 + r)$  when  $r = \ell - 6$ . The corresponding difference multiset is  $\{4, 2, 2\}/\{3, 3, 1\} + \ell - 6$ . Therefore, by (11.6),

$$\begin{aligned} \bigcup_{r=1}^{\ell-6} \mathcal{P}^{(r)} / \bigcup_{r=1}^{\ell-6} \mathcal{Q}^{(r)} &= (\{4, 2\}/\{3, 3\} + \ell - 7) \cup (\{4, 2, 2\}/\{3, 3, 1\} + \ell - 6) \\ &= \{5, 4, 3, 3, 2\}/\{4, 4, 3, 3, 2\} + \ell - 7 \\ &= \{5\}/\{4\} + \ell - 7 \\ &= \{\ell - 2\}/\{\ell - 3\}. \end{aligned}$$

The final six rows of the pyramids (region  $C$ ) are, with the constant factor  $+ m$  removed,

$$\begin{array}{cccccccccccc} \ell - 1 & \ell - 2 & \ell - 3 & \ell - 3 & \ell - 2 & \ell - 2 & \ell - 2 & \ell - 2 & \ell - 2 & \ell - 2 & \ell - 3 & \ell - 2 \\ \ell & \ell - 1 & \ell - 2 & \ell - 1 & \ell - 1 & & \ell - 1 & \ell - 1 & \ell - 1 & \ell - 1 & \ell & \\ \ell + 1 & \ell & \ell & \ell & & & \ell & \ell & \ell & \ell + 2 & & \\ \ell + 2 & \ell + 2 & \ell + 1 & & & & \ell + 1 & \ell + 1 & \ell + 3 & & & \\ \ell + 4 & \ell + 3 & & & & & \ell + 2 & \ell + 4 & & & & \\ \ell + 5 & & & & & & \ell + 5 & & & & & \end{array},$$

respectively. The corresponding difference multiset is  $\{\ell - 3\}/\{\ell - 2\}$ . Hence the multisets of entries involving  $m$  in  $P$  and  $Q$  are the same.  $\square$

We end by remarking that, by Proposition 3.6, an exceptional equivalence  $\lambda_{\ell} \sim_{\ell} \mu$  lifts to an isomorphism  $\nabla^{\lambda} \text{Sym}^{\ell} E \cong \nabla^{\mu} \text{Sym}^{\mu} E$  of representations of  $\text{GL}(E)$  if and only if  $|\lambda| = |\mu|$ . A computer search shows that, by size of partitions, the smallest such example is

$$(5, 4, 3^5, 1^6)_{14} \sim_{14} (5, 3^6, 2^3, 1)$$

between two partitions of 30. As a curiosity, we note that 146 of the 493 exceptional equivalences  $\lambda_{\ell} \sim_{\ell} \mu$  between partitions  $\lambda$  and  $\mu$  of size at most 35 have  $\ell = 8$ . Next most frequent are  $\ell = 11$  with 99 equivalences and  $\ell = 14$  with 56 equivalences.

## 12. SOLITARY PARTITIONS

**Definition 12.1.** A partition  $\lambda$  is *solitary* if whenever  $\lambda \ell \sim_m \mu$  with  $\ell \geq \ell(\lambda)$  and  $m \geq \ell(\mu)$ , we have  $\ell = m$  and either  $\mu = \lambda$  or  $\mu = \lambda^{\circ(\ell+1)}$ .

By Theorem 1.5, the equivalences in Definition 12.1 exist for any partition. The solitary partitions are therefore those with the fewest possible prime plethystic equivalences. Using Theorem 1.5, Theorem 1.11 reduces to the following proposition. Recall that  $\delta(k) = (k, k-1, \dots, 1)$ .

**Proposition 12.2.** *For each  $k \in \mathbf{N}$ , the partition  $\delta(k)$  is solitary.*

*Proof.* Suppose that  $\delta(k) \ell \sim_m \mu$  where  $\ell \geq k$  and  $m \geq \ell(\mu)$  and that  $\mu \neq \delta(k)$ . Using the difference multiset notation from §3.1, Theorem 3.4(h) implies that

$$(12.1) \quad \frac{C(\mu) + m + 1}{C(\delta(k)) + \ell + 1} = \frac{H(\mu)}{H(\delta(k))}.$$

Let  $u$  be the number of boxes  $(i, j) \in [\mu]$  such that  $h_{(i,j)}(\mu) = 2$ ; we say that such boxes are *2-hooks*. Since all the hook lengths in  $\delta(k)$  are odd, the multiplicity of 2 in the right-hand side is  $u$ . By Lemma 4.4,  $\mu$  has precisely  $k$  removable boxes. Since  $\mu \neq \delta(k)$ ,  $\mu$  has at least one 2-hook, and so  $u \geq 1$ . For any partition  $\nu$  and  $n$  such that  $n \geq \ell(\nu)$ , we have  $2 \in C(\nu) + n + 1$  if and only if  $n = \ell(\nu)$ ; in this case the multiplicity is 1. Therefore  $u \leq 1$  and we conclude that  $\mu$  has a unique 2-hook. Moreover,  $m = \ell(\mu)$  and  $\ell > k$ .

To identify  $\ell$  we use Proposition 4.7 to get  $a(\delta(k)) + \ell = a(\mu) + m$ . (Or one may follow the proof of this proposition and instead compare greatest elements in (12.1).) Hence  $\ell = a(\mu) + m - k$ . Since  $\mu$  has a unique 2-hook and precisely  $k$  removable boxes, it is obtained from  $\delta(k)$  by inserting either (i)  $d$  new columns or (ii)  $d$  new rows of a fixed length  $c \leq k$ . We consider these cases separately below. Observe that in either case the greatest hook length in either  $\mu$  or  $\delta(k)$  is  $(k+d-1) + (k-1) + 1 = 2k+d-1$ , coming uniquely from the box  $(1, 1)$  of  $\mu$ . Hence  $2k+d-1$  has multiplicity 1 in the right-hand side of (12.1).

- (i) In this case  $a(\mu) = k+d$  and  $\ell(\mu) = k$ . Hence  $m = k$  and  $\ell = k+d$ . In  $C(\mu) + m + 1$ , the greatest element is  $(k+d-1) + (m+1) = 2k+d$  and, since  $\mu_1 > \mu_2$ , the next greatest element is  $(k+d-1-1) + (m+1) = 2k+d-1$ , also with multiplicity 1. In  $C(\delta(k)) + \ell + 1$ , the second greatest element is  $(k-1-1) + (\ell+1) = 2k+d-1$ , again with multiplicity 1. Therefore  $2k+d-1$  has multiplicity 0 in the left-hand side of (12.1), a contradiction.
- (ii) In this case  $a(\mu) = k$  and  $\ell(\mu) = k+d$ . Hence  $m = k+d$  and  $\ell = m$ . A similar argument considering the multiplicity of  $2k+d-1$  in the left-hand side of (12.1) shows that  $2k+d-1$  must appear with multiplicity 2 in  $C(\mu) + m + 1$ . Hence  $\mu_1 = \mu_2$  and  $c = k$ . This

shows that  $\mu$  is the complement of  $\delta(k)$  in the box with  $k + d + 1$  rows; that is  $\mu = \delta(k)^{\circ(\ell+1)}$ .

This completes the proof.  $\square$

#### ACKNOWLEDGEMENTS

We thank two anonymous referees for their helpful criticisms and comments.

#### REFERENCES

- [1] Christopher Bowman and Rowena Paget, *The uniqueness of plethystic factorisation*, arXiv:1903.11133 (May 2019), 12 pages.
- [2] Michel Brion, *Stable properties of plethysm: on two conjectures of Foulkes*, Manuscripta Math. **80** (1993), 347–371.
- [3] Leandro Cagliero and Daniel Penazzi, *A new generalization of Hermite’s reciprocity law*, J. Algebr. Comb. **43** (2016), 399–416.
- [4] Arthur Cayley, *An introductory memoir upon quantic*s, Philos. Trans. Roy. Soc. Lond. **144** (1854), 245–258.
- [5] Man-Wai Cheung, Christian Ikenmeyer, and Sevak Mkrtchyan, *Symmetrizing tableaux and the 5th case of the Foulkes conjecture*, J. Symbolic Comput. **80** (2017), 833–843.
- [6] David A. Craven, *Symmetric group character degrees and hook numbers*, Proc. Lond. Math. Soc. (3) **96** (2008), 26–50.
- [7] Melanie de Boeck, Rowena Paget, and Mark Wildon, *Plethysms of symmetric functions and highest weight representations*, Submitted. ArXiv:1810.03448 (September 2018), 35 pages.
- [8] H. O. Foulkes, *Concomitants of the quintic and sextic up to degree four in the coefficients of the ground form*, J. London Math. Soc. **25** (1950), 205–209.
- [9] M. Fulmek and C. Krattenthaler. *The number of rhombus tilings of a symmetric hexagon which contain a fixed rhombus on the symmetry axis. I*, Ann. Comb. **2** (1998), 19–41.
- [10] William Fulton, *Young tableaux*, London Mathematical Society student texts, vol. 35, CUP, 1997.
- [11] William Fulton and Joe Harris, *Representation theory*, Graduate Texts in Mathematics, vol. 129, Springer-Verlag, New York, 1991, A first course, Readings in Mathematics.
- [12] William Fulton and Joe Harris, *Representation theory, a first course*, Graduate Texts in Mathematics (Readings in Mathematics), vol. 129, Springer, 1991.
- [13] Eugenio Giannelli, *On the decomposition of the Foulkes module*, Arch. Math. (Basel) **100** (2013), 201–214.
- [14] Charles Hermite, *Sur la theorie des fonctions homogenes à deux indéterminées*, Cambridge and Dublin Math. J. **9** (1854), 172–217.
- [15] Takeshi Ikeda and Hiroshi Naruse, *Excited Young diagrams and equivariant Schubert calculus*, Trans. Amer. Math. Soc. **361** (2009), 5193–5221.
- [16] Wolfram Research, Inc., *Mathematica, Version 12.0*, Champaign, IL, 2019.
- [17] Mark Kac, *Can one hear the shape of a drum?*, Amer. Math. Monthly **73** (1966), part II, 1–23.
- [18] Ronald C. King, *Young tableaux, Schur functions and SU(2) plethysms*, J. Phys. A **18** (1985), 2429–2440.

- [19] Nicholas A. Loehr and Jeffrey B. Remmel, *A computational and combinatorial exposé of plethystic calculus*, J. Algebraic Combin. **33** (2011), 163–198.
- [20] I. G. Macdonald, *Symmetric functions and Hall polynomials*, second ed., Oxford Mathematical Monographs, The Clarendon Press Oxford University Press, New York, 1995, With contributions by A. Zelevinsky, Oxford Science Publications.
- [21] Percy A. MacMahon, *XVI. memoir on the theory of the partition of numbers. Part I*, Phil. Trans. Roy. Soc. Lond. A: Maths. Phys. Eng. Sci. **187** (1896), 619–673.
- [22] L. Manivel, *An extension of the Cayley-Sylvester formula*, European J. Combin. **28** (2007), 1839–1842.
- [23] Eoghan McDowell, *Tensor products of modular representations of  $SL_2(\mathbb{F}_p)$  and a random walk on their indecomposable summands*, arXiv:1904.13263 (April 2019), 30 pages.
- [24] Alejandro H. Morales, Igor Pak, and Greta Panova, *Hook formulas for skew shapes I.  $q$ -analogues and bijections*, J. Combin. Theory Ser. A **154** (2018), 350–405.
- [25] Hiroshi Naruse, *Schubert calculus and hook formula*, talk given September 2014, [www.emis.de/journals/SLC/wpapers/s73vortrag/naruse.pdf](http://www.emis.de/journals/SLC/wpapers/s73vortrag/naruse.pdf).
- [26] Rowena Paget and Mark Wildon, *Generalized Foulkes modules and maximal and minimal constituents of plethysms of Schur functions*, Proc. Lond. Math. Soc. (3) **118** (2019), 1153–1187.
- [27] Simon Peyton Jones et al., *The Haskell 98 language and libraries: The revised report*, Journal of Functional Programming **13** (2003), 0–255, <http://www.haskell.org/definition/>.
- [28] T. A. Springer, *Invariant theory*, Lecture Notes in Mathematics, Vol. 585, Springer-Verlag, Berlin-New York, 1977.
- [29] Richard P. Stanley, *Enumerative combinatorics. Vol. 2*, Cambridge Studies in Advanced Mathematics, vol. 62, Cambridge University Press, Cambridge, 1999, With a foreword by Gian-Carlo Rota and appendix 1 by Sergey Fomin.
- [30] ———, *Enumerative combinatorics. Volume 1*, second ed., Cambridge Studies in Advanced Mathematics, vol. 49, Cambridge University Press, Cambridge, 2012.
- [31] J. J. Sylvester, *On the calculus of forms, otherwise the theory of invariants*, Cambridge and Dublin Maths. J. **9** (1854), 85–103.
- [32] B. G. Wybourne, *Hermite’s reciprocity law and the angular-momentum states of equivalent particle configurations*, J. Math. Phys. **10** (1969), 467–471.